

FLEX I/O System with ControlLogix for SIL 2



Catalog Number Bulletin 1794
Reference Manual



Important User Information

Solid state equipment has operational characteristics differing from those of electromechanical equipment. Safety Guidelines for the Application, Installation and Maintenance of Solid State Controls (publication [SGI-1.1](#) available from your local Rockwell Automation sales office or online at <http://literature.rockwellautomation.com>) describes some important differences between solid state equipment and hard-wired electromechanical devices. Because of this difference, and also because of the wide variety of uses for solid state equipment, all persons responsible for applying this equipment must satisfy themselves that each intended application of this equipment is acceptable.





In no event will Rockwell Automation, Inc. be responsible or liable for indirect or consequential damages resulting from the use or application of this equipment.

The examples and diagrams in this manual are included solely for illustrative purposes. Because of the many variables and requirements associated with any particular installation, Rockwell Automation, Inc. cannot assume responsibility or liability for actual use based on the examples and diagrams.

No patent liability is assumed by Rockwell Automation, Inc. with respect to use of information, circuits, equipment, or software described in this manual.

Reproduction of the contents of this manual, in whole or in part, without written permission of Rockwell Automation, Inc., is prohibited.

Throughout this manual, when necessary, we use notes to make you aware of safety considerations.

WARNING 	Identifies information about practices or circumstances that can cause an explosion in a hazardous environment, which may lead to personal injury or death, property damage, or economic loss.
IMPORTANT	Identifies information that is critical for successful application and understanding of the product.
ATTENTION 	Identifies information about practices or circumstances that can lead to: personal injury or death, property damage, or economic loss. Attentions help you identify a hazard, avoid a hazard, and recognize the consequence.
SHOCK HAZARD 	Labels may be on or inside the equipment, such as a drive or motor, to alert people that dangerous voltage may be present.
BURN HAZARD 	Labels may be on or inside the equipment, such as a drive or motor, to alert people that surfaces may reach dangerous temperatures.

Allen-Bradley, Rockwell Automation, FLEX I/O, RSLinx, RSLogix 5000 and TechConnect are trademarks of Rockwell Automation, Inc.

Trademarks not belonging to Rockwell Automation are property of their respective companies.

Introduction

This application manual is intended to describe the FLEX I/O with ControlLogix Control System components available from Rockwell Automation that are suitable for use in SIL2 applications. Use this manual in conjunction with publication [1756-RM001](#)

Alternate architecture can be used in SIL2 applications if they are approved by a certifying agency.

Manual Set-Up

This manual is designed to make clear how the FLEX I/O with ControlLogix Control System can be SIL2-certified. Table Preface.1 lists the information available in each section.

Table Preface.1

Section:	Title:	Description:
Chapter 1	SIL Policy	Introduction to the SIL policy and how that policy relates to FLEX I/O with a ControlLogix system.
Chapter 2	ControlLogix Communications	Description of the ControlLogix communications modules used in the SIL2-certified FLEX I/O with ControlLogix system.
Chapter 3	FLEX I/O Modules	Description of the FLEX I/O modules used in the SIL2-certified FLEX I/O with ControlLogix system.
Chapter 4	General Requirements for Application Software	Application software requirements for using ControlLogix and FLEX modules.
Chapter 5	Technical SIL2 Requirements for the Application Program	Guidelines for application development in RSLogix 5000 as they relate to SIL2.
Appendix A	Failure Estimates	Failure rates based on field returns.

Understanding Terminology

The following table defines acronyms used in this manual.

Table Preface.2 List of Acronyms Used Throughout the Safety Application Manual

Acronym:	Full Term:	Definition:
CIP	Control and Information Protocol	A messaging protocol used by Logix5000™ systems. It is a native communications protocol used on ControlNet™ communications networks, among others.
DC	Diagnostic Coverage	The ratio of the detected failure rate to the total failure rate.
EN	European Norm.	The official European Standard
GSV	Get System Value	A ladder logic output instruction that retrieves specified controller status information and places it in a destination tag.

Table Preface.2 List of Acronyms Used Throughout the Safety Application Manual

Acronym:	Full Term:	Definition:
MTBF	Mean Time Between Failures	Average time between failure occurrences.
MTTR	Mean Time to Restoration	Average time needed to restore normal operation after a failure has occurred.
PADT	Programming and Debugging Tool	RSLogix 5000 software used to program and debug a SIL2-certified FLEX I/O with ControlLogix application.
PC	Personal Computer	Computer used to interface with, and control, a ControlLogix system via RSLogix 5000 programming software.
PFD	Probability of Failure on Demand	The average probability of a system to fail to perform its design function on demand.
PFH	Probability of Failure per Hour	The probability of a system to have a dangerous failure occur per hour.
1oo1	One out of one	A 1oo1 (one out of one) architecture consists of a single channel where any dangerous failure leads to a failure of the safety function.
1oo2	One out of two	A 1oo2 (one out of two) architecture consists of two channels connected in parallel such that either channel can process the safety function.

SIL Policy

This chapter introduces you to the SIL policy and how the ControlLogix/FLEX I/O system meets the requirements for SIL2 certification.

For information about:	See page:
Introduction to SIL	1-1
SIL2 Certification	1-2
Proof Tests	1-3
SIL2-Certified FLEX I/O System Components	1-5
Hardware Designs and Firmware Functions	1-8
Hardware Designs and Firmware Functions	1-8
Difference Between PFD and PFH	1-8
SIL Compliance Distribution and Weight	1-13
Response Times	1-13

Introduction to SIL

Certain catalog numbers (listed in Table 1.1 on page 1-5) of the FLEX I/O with ControlLogix system are **type-approved** and certified for use in SIL2 applications, according to IEC 61508. SIL requirements are based on the standards current at the time of certification.

These requirements consist of mean time between failures (MTBF), probability of failure, failure rates, diagnostic coverage and safe failure fractions that fulfill SIL2 criteria. The results make the ControlLogix/FLEX I/O system suitable up to, and including, SIL2. When the ControlLogix/FLEX I/O system is in the maintenance or programming mode, the user is responsible for maintaining a safe state.

For support in creation of programs, the PADT (Programming and Debugging Tool) is required. The PADT for ControlLogix/FLEX I/O is RSLogix 5000, per IEC 61131-3, and this Safety Reference Manual.

The TUV Rheinland has approved the ControlLogix/FLEX I/O system for use in up to and including SIL 2 safety related applications in which the de-energized state is considered to be the safe state. All of the examples related to I/O included in this manual are based on achieving de-energization as the safe state for typical Emergency Shutdown (ESD) Systems.

SIL2 Certification

Figure 1.1 shows a typical SIL loop, including:

- the overall safety loop
- the ControlLogix/FLEX I/O portion of the overall safety loop
- how other devices (for example, HMI) connect to the loop, while operating outside the loop

Figure 1.1

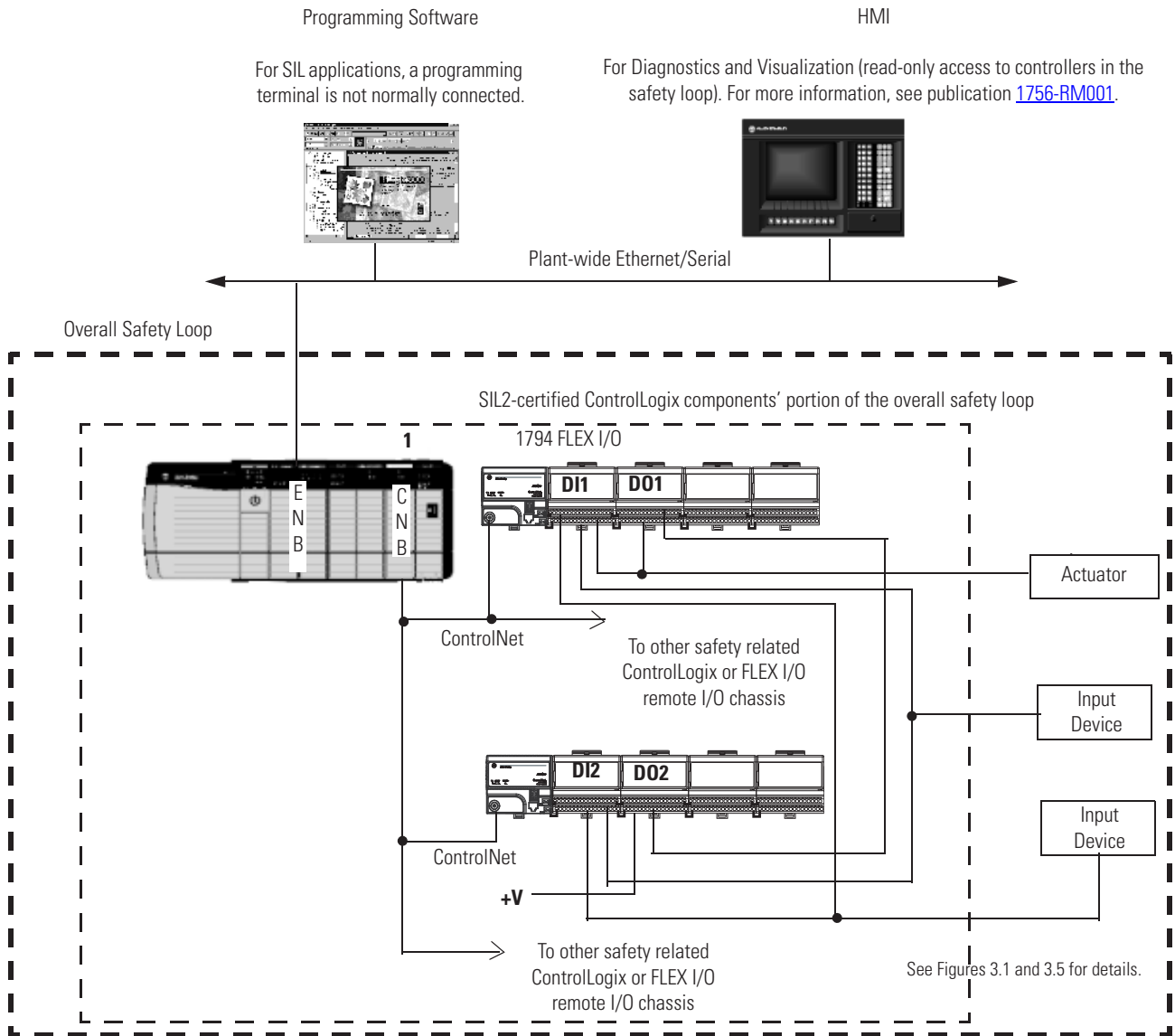

Note 1: Multiple 1756-CNB or -CNBR modules can be installed into the chassis as needed. Other configurations are possible as long as they are SIL2 approved.

Note 2: Two adapters are required for meeting SIL2 as shown in the figure. The adapters can be either ControlNet or Ethernet and must be from the list of approved products.

IMPORTANT

Important Note related to published PFDs.

- The user must choose the appropriate PFD depending on combinations and the appropriate 1oo1 or 1oo2 configuration.
- Discrete and analog inputs must be used in a 1oo2 configuration for SIL 2.
- Adapters must be used in a 1oo2.
- Outputs may be 1oo2 in series or 1oo1 monitored by an input with an external relay as a secondary device to remove power.
- Some specialized inputs can only be wired to a single sensor such as thermocouples and two 1oo1 PFDs must be used for each.
- The total PFD for two 1oo1s is the sum of both.

IMPORTANT

The system user is responsible for:

- the set-up, SIL rating and validation of any sensors or actuators connected to the ControlLogix/FLEX I/O control system.
- project management and functional testing, programming the application software and the module configuration according to the description in the following chapters.

The SIL2 portion of the certified system excludes the development tools and display/human machine interface (HMI) devices; these tools and devices are not part of the run time control loop.

Proof Tests

IEC 61508 requires the user to perform various proof tests of the equipment used in the system. Proof tests are performed at user-defined times (for example, proof test intervals can be once a year, once every two years or whatever timeframe is appropriate) and include some of the following tests:

- Testing of all fault routines to verify that process parameters are monitored properly and the system reacts properly when a fault condition arises.
- Testing of digital input or output channels to verify that they are not stuck in the ON or OFF state.

- Calibration of analog input and output modules to verify that accurate data is obtained from and used on the modules.

IMPORTANT

Users' specific applications will determine the timeframe for the proof test interval.

However, keep in mind that the Probability of Failure on Demand (PFD) calculations listed in Table 1.2 on page 1-8 use a proof test interval of once per year. If the proof test interval is changed, the information must be recalculated.

For more information on system proof tests, see Publication [1756-RM001](#). For more information on the necessary I/O module, see Table 1.1.

SIL2-Certified FLEX I/O System Components

Table 1.1 lists the components available for use in a SIL2-certified FLEX I/O system. For a list of ControlLogix SIL2 certified products, see publication [1756-RM001](#).

Table 1.1 FLEX I/O Components For Use in the SIL 2 System

Device Type:	Catalog Number: ⁽¹⁾	Description:	Series ⁽²⁾	Firmware Revision: (2) (3)	Related Documentation ⁽⁴⁾ with More Information on Catalog Number:	
					Installation Instructions:	User Manual:
Adapter	1794-ACN15	ControlNet Single Media Adapter	C	4.3 5.1, 5.2, 5.3, 5.x	1794-IN101	NA
			D	10.1, 10.2, 10.3, 10.x		
	1794-ACNR15	ControlNet Redundant Media Adapter	C	4.3 5.1, 5.2, 5.3, 5.x	1794-IN101	NA
			D	10.1, 10.2, 10.3, 10.x		
	1794-ACNR15XT		C	5.1, 5.2, 5.3, 5.x	1794-IN128	NA
			D	10.1, 10.2, 10.3, 10.x		
	1794-AENT	10/100Mb Ethernet Communication Adapter	B	4.1 4.2, 4.x	1794-IN082	NA
	1794-AENTR		A	1.011, 1.x	1794-IN131	1794-UM066
	1794-AENTRXT					
I/O Modules - Digital	1794-IB16	16 Sink Input Module	A	NA	1794-IN093	NA
	1794-IB10XOB6	10 Input/6 Output Module	A	NA	1794-IN083	
	1794-OB16	16 Source Output Module	A	NA	1794-IN094	
	1794-OB16P	16 Protected Output Module	A	NA	1794-IN094	
	1794-OB8EP	8 Protected Output Module	A	NA	1794-IN094	
	1794-OW8	Isolated Relay Output Module	A	NA	1794-IN019	
	1794-OB8EPXT	8 Protected Output Module	A	NA	1794-IN124	
	1794-IB16XT	16 Sink Input Module	A	NA		
	1794-OB16PXT	16 Protected Output Module	A	NA		
	1794-IB10XOB6XT	10 Input/6 Output Combo Module	A	NA		
	1794-OW8XT	8 Relay Output Module	A	NA	1794-IN019	

Table 1.1 FLEX I/O Components For Use in the SIL 2 System

Device Type:	Catalog Number: ⁽¹⁾	Description:	Series ⁽²⁾	Firmware Revision: (2) (3)	Related Documentation ⁽⁴⁾ with More Information on Catalog Number:	
					Installation Instructions:	User Manual:
I/O Modules - Analog	1794-IE8	8 Input Analog Module	B	NA	1794-IN100	1794-UM002
	1794-IF4I	4 Isolated Input Analog Module	A	F, G, H, I, I.x	1794-IN038	1794-UM008
	1794-IF2XOF2I	2 In/2 Out Isolated Combo Module	A	F, G, H, I, I.x	1794-IN039	1794-UM008
	1794-OE4	4 Output Analog Module	B	NA	1794-IN100	1794-UM002
	1794-OF4I	4 Isolated Output Analog Module	A	F, G, H, I, I.x	1794-IN037	1794-UM008
	1794-IT8	Thermocouple Input Module	A	K, K.x	1794-IN021	1794-UM007
	1794-IR8	RTD Input Module	A	K, K.x	1794-IN021	1794-UM004
	1794-IRT8	TC/RTD Input Module	B	B, D, E, E.1, E.x	1794-IN050	1794-UM012
	1794-IJ2	2 Ch. Frequency Counter Module	A	D	1794-IN049	1794-UM011
	1794-IP4	4 Ch. Pulse Counter Module	B	4, 4.x	1794-IN064	1794-UM016
I/O Modules - Analog	1794-IE4XOE2XT	4 Input/2 Output Analog Combo Module	B	NA	1794-IN125	NA
	1794-IE8XT	8 Input analog Module	B	NA		
	1794-OE4XT	4 Output Analog Module	B	NA		
	1794-IF2XOF2IXT	2 Input/2 Output Isolated Analog Combo Module	A	I, I.x	1794-IN129	
	1794-IF4IXT	4 Isolated Input Analog Module	A	I, I.x		
	1794-OF4IXT	4 Isolated Output Analog Module	A	I, I.x		
	1794-IF4ICFXT	4 Isolated Input Analog Module	A	I, I.x	1794-IN130	
	1794-IJ2XT	2 Ch. Frequency Counter Module	A	E, E.x	1794-IN049	
1794-IRT8XT	8 TC/RTD Input Analog Module	B	D, E, E.1, E.x	1794-IN050		

Table 1.1 FLEX I/O Components For Use in the SIL 2 System

Device Type:	Catalog Number: ⁽¹⁾	Description:	Series ⁽²⁾	Firmware Revision: (2) (3)	Related Documentation ⁽⁴⁾ with More Information on Catalog Number:	
					Installation Instructions:	User Manual:
Terminal Base Units	1794-TB3	3-Wire Terminal Base Unit	A	NA	1794-IN092	NA
	1794-TB3S	3-Wire Terminal Base Unit	A	NA		
	1794-TB3T	Temperature Terminal Base Unit	A	NA		
	1794-TB3TS	Spring-clamp Temperature Base Unit	A	NA		
	1794-TB3G	Cage-clamp Gen. Terminal Base Unit	A	NA		
	1794-TB3GS	Spring-clamp Gen. Terminal Base Unit	A	NA		
	1794-TBN	NEMA Terminal Base Unit	A	NA		
	1794-TBNF	Fused NEMA Terminal Base Unit	A	NA		

⁽¹⁾ Certain catalog numbers have a K suffix. This indicates a conformally coated version of the product. These K versions have the same SIL2 certification as the non-K versions.

⁽²⁾ The FW versions marked with extension .x (x can be 0 ... 99) are constitute to minor changes for enhancements. The test institute will be informed on any change.

⁽³⁾ Users must use these series and firmware revisions for their application to be SIL2 certified. Firmware revisions are available by visiting <http://support.rockwellautomation.com/ControlFlash/>

⁽⁴⁾ These publications are available from Rockwell Automation by visiting <http://literature.rockwellautomation.com>.

Hardware Designs and Firmware Functions

Diagnostic hardware designs and firmware functions designed into the ControlLogix/FLEX I/O platform allow it to achieve at least SIL2 certification in a single-controller configuration. These diagnostic features are incorporated into specific FLEX I/O components, such as the:

- adapter
- power supply
- I/O modules
- terminal base units

and are covered in subsequent sections. The ControlLogix/FLEX I/O platform's designs, features and characteristics make it one of the most intelligent platforms.

Difference Between PFD and PFH

Table 1.2 and Table 1.3 present values of the PFDs and PFHs for the specific FLEX I/O products evaluated by TUV.

FLEX I/O uses the same PFD and PFH assumptions as stated in publication [1756-RM001](#).

Table 1.2 FLEX I/O Product Probability of Failure on Demand (PFD) Calculations (T₁ = 1 yr)

Catalog Number	Description	Mean Time Between Failure (MTBF) ⁽¹⁾	λ ⁽³⁾	Calculated PFD
				1oo2 architecture
1794-ACN15	ControlNet Single Media Adapter	8,223,684	1.22E-07	2.15E-06
1794-ACNR15	ControlNet Redundant Media Adapter	8,223,684	1.22E-07	2.15E-06
1794-AENT	10/100Mb Ethernet Communication Adapter	691,134	1.45E-06	2.76E-05
1794-AENTR	10/100Mb Ethernet Redundant Communication Adapter	1,268,070	7.89E-07	1.45E-05
1794-IB10XOB6	10 Input/6 Output Module	4,943,442	2.02E-07	3.60E-06
1794-IB16	16 Sink Input Module	4,105,090	2.44E-07	4.34E-06
1794-IE8	Analog Input Module	37,952,679	2.63E-08	4.64E-07
1794-IF2XOF2I	Isolated Analog Input/Output Module	25,296,960	3.95E-08	6.97E-07
1794-IF4I	Isolated Analog Input Module	11,746,343	8.51E-08	1.50E-06
1794-IJ2	Frequency Counter Module	2,418,321	4.14E-07	7.45E-06
1794-IP4	Pulse Counter Module	2,375,360	4.21E-07	7.58E-06
1794-IR8	RTD Input Module	6,191,655	1.62E-07	2.87E-06
1794-IRT8	TC/RTD/mV Input Module	1,182,438	8.46E-07	1.56E-05
1794-IT8	Thermocouple Input Module	1,564,324	6.39E-07	1.17E-05
1794-OB16	16 Source Output Module	1,883,594	5.31E-07	9.62E-06
1794-OB16P	Protected Output Module	2,135,280	4.68E-07	8.46E-06

Table 1.2 FLEX I/O Product Probability of Failure on Demand (PFD) Calculations ($T_1 = 1$ yr)

Catalog Number	Description	Mean Time Between Failure (MTBF) ⁽¹⁾	λ ⁽³⁾	Calculated PFD
				1oo2 architecture
1794-OB8EP	Protected Output Module	2,389,669 ⁽²⁾	4.18E-07	7.54E-06
1794-OE4	Analog Output Module	23,807,086	4.20E-08	7.41E-07
1794-OF4I	Isolated Analog Output Module	7,191,128	1.39E-07	2.47E-06
1794-OW8	Relay Output Module	14,766,876	6.77E-08	1.20E-06
1794-TB3	Terminal Base Units	21,128,346 ⁽²⁾	4.73E-08	8.35E-07
1794-TB3G	Generic Terminal Base Units	27,320,800	3.66E-08	6.45E-07
1794-TB3GS	Generic Terminal Base Units	46,425,600	2.15E-08	3.79E-07
1794-TB3S	Terminal Base Unit	71,433,747 ⁽²⁾	1.40E-08	2.46E-07
1794-TB3T	Temperature Terminal Base Units	73,096,226 ⁽²⁾	1.37E-08	2.41E-07
1794-TB3TS	Temperature Terminal Base Units	75,763,399 ⁽²⁾	1.32E-08	2.32E-07
1794-TBN	Terminal Base Units	75,716,615	1.32E-08	2.32E-07
1794-TBNF	Fused Terminal Base Units	4,812,320 ⁽²⁾	2.08E-07	3.70E-06
1794-ACNR15XT	ControlNet Redundant Media Adapter	8,223,684	1.22E-07	2.15E-06
1794-AENTRXT	10/100Mb Ethernet Redundant Communication Adapter	1,268,070	7.89E-07	1.45E-05
1794-OB8EPXT	8 Protected Output Module	14,771,049	6.77E-08	1.20E-06
1794-IB16XT	16 Sink Input Module	35,587,189	2.81E-08	4.95E-07
1794-OB16PXT	16 Protected Output Module	26,709,401	3.74E-08	6.60E-07
1794-IB10XOB6XT	10 Input/6 Output Combo Module	22,202,487	4.50E-08	7.94E-07
1794-OW8XT	8 Relay Output Module	18,518,519	5.40E-08	9.53E-07
1794-IE4XOE2XT	4 Input/2 Output Analog Combo Module	11,800,802	8.47E-08	1.50E-06
1794-IE8XT	8 Input analog Module	14,041,000	7.12E-08	1.26E-06
1794-OE4XT	4 Output Analog Module	11,381,744	8.79E-08	1.55E-06
1794-IF2XOF2IXT	2 Input/2 Output Isolated Analog Combo Module	6,317,918	1.58E-07	2.81E-06
1794-IF4IXT	4 Isolated Input Analog Module	7,297,140	1.37E-07	2.43E-06
1794-IF4ICFXT	4 Isolated Input Analog Module	7,297,140	1.37E-07	2.43E-06
1794-OF4IXT	4 Isolated Output Analog Module	5,493,902	1.82E-07	3.24E-06
1794-IJ2XT	2 Ch. Frequency Counter Module	11,714,128	8.54E-08	1.51E-06
1794-IRT8XT	8 TC/RTD Input Analog Module	8,204,792	1.22E-07	2.16E-06

⁽¹⁾ MTBF measured in hours.

⁽²⁾ Calculated using field-based values for components

⁽³⁾ λ = Failure Rate = 1/MTBF

Table 1.3 FLEX I/O Product Probability of Undetected Dangerous Failure per Hour (PFH) Calculations ($T_1 = 1$ yr)

Catalog Number	Description	Mean Time Between Failure (MTBF) ⁽¹⁾	λ ⁽³⁾	Calculated PFH 1oo2 architecture
1794-ACN15	ControlNet Single Media Adapter	8,223,684	1.22E-07	8.64E-10
1794-ACNR15	ControlNet Redundant Media Adapter	8,223,684	1.22E-07	8.64E-10
1794-AENT	10/100Mb Ethernet Communication Adapter	691,134	1.45E-06	1.19E-08
1794-AENTR	10/100Mb Ethernet Redundant Communication Adapter	1,268,070 ⁽²⁾	7.89E-07	6.05E-09
1794-IB10XOB6	10 Input/6 Output Module	4,943,442	2.02E-07	1.45E-09
1794-IB16	16 Sink Input Module	4,105,090	2.44E-07	1.76E-09
1794-IE8	Analog Input Module	37,952,679	2.63E-08	1.85E-10
1794-IF2XOF2I	Isolated Analog Input/Output Module	25,296,960	3.95E-08	2.78E-10
1794-IF4I	Isolated Analog Input Module	11,746,343	8.51E-08	6.02E-10
1794-IJ2	Frequency Counter Module	2,418,321	4.14E-07	3.04E-09
1794-IP4	Pulse Counter Module	2,375,360	4.21E-07	3.10E-09
1794-IR8	RTD Input Module	6,191,655	1.62E-07	1.15E-09
1794-IRT8	TC/RTD/mV Input Module	1,182,438	8.46E-07	6.53E-09
1794-IT8	Thermocouple Input Module	1,564,324	6.39E-07	4.82E-09
1794-OB16	16 Source Output Module	1,883,594	5.31E-07	3.96E-09
1794-OB16P	Protected Output Module	2,135,280	4.68E-07	3.47E-09
1794-OB8EP	Protected Output Module	2,389,669 ⁽²⁾	4.18E-07	3.08E-09
1794-OE4	Analog Output Module	23,807,086	4.20E-08	2.96E-10
1794-OF4I	Isolated Analog Output Module	7,191,128	1.39E-07	9.90E-10
1794-OW8	Relay Output Module	14,766,876	6.77E-08	4.78E-10
1794-TB3	Terminal Base Units	21,128,346 ⁽²⁾	4.73E-08	3.33E-10
1794-TB3G	Generic Terminal Base Units	27,320,800	3.66E-08	2.57E-10
1794-TB3GS	Generic Terminal Base Units	46,425,600	2.15E-08	1.51E-10
1794-TB3S	Terminal Base Unit	71,433,747 ⁽²⁾	1.40E-08	9.82E-11
1794-TB3T	Temperature Terminal Base Units	73,096,226 ⁽²⁾	1.37E-08	9.59E-11
1794-TB3TS	Temperature Terminal Base Units	75,763,399 ⁽²⁾	1.32E-08	9.25E-11
1794-TBN	Terminal Base Units	75,716,615	1.32E-08	9.26E-11
1794-TBNF	Fused Terminal Base Units	4,812,320 ⁽²⁾	2.08E-07	1.49E-09
1794-ACNR15XT	ControlNet Redundant Media Adapter	8,223,684	1.22E-07	8.64E-10
1794-AENTRXT	10/100Mb Ethernet Redundant Communication Adapter	1,268,070 ⁽²⁾	7.89E-07	6.05E-09
1794-OB8EPXT	8 Protected Output Module	14,771,049	6.77E-08	4.78E-10
1794-IB16XT	16 Sink Input Module	35,587,189	2.81E-08	1.97E-10
1794-OB16PXT	16 Protected Output Module	26,709,401	3.74E-08	2.63E-10
1794-IB10XOB6XT	10 Input/6 Output Combo Module	22,202,487	4.50E-08	3.17E-10
1794-OW8XT	8 Relay Output Module	18,518,519	5.40E-08	3.80E-10

Table 1.3 FLEX I/O Product Probability of Undetected Dangerous Failure per Hour (PFH) Calculations ($T_1 = 1$ yr)

Catalog Number	Description	Mean Time Between Failure (MTBF) ⁽¹⁾	λ ⁽³⁾	Calculated PFH 1oo2 architecture
1794-IE4XOE2XT	4 Input/2 Output Analog Combo Module	11,800,802	8.47E-08	5.99E-10
1794-IE8XT	8 Input analog Module	14,041,000	7.12E-08	5.03E-10
1794-OE4XT	4 Output Analog Module	11,381,744	8.79E-08	6.22E-10
1794-IF2XOF2IXT	2 Input/2 Output Isolated Analog Combo Module	6,317,918	1.58E-07	1.13E-09
1794-IF4IXT	4 Isolated Input Analog Module	7,297,140	1.37E-07	9.75E-10
1794-IF4ICFXT	4 Isolated Input Analog Module	7,297,140	1.37E-07	9.75E-10
1794-OF4IXT	4 Isolated Output Analog Module	5,493,902	1.82E-07	1.30E-09
1794-IJ2XT	2 Ch. Frequency Counter Module	11,714,128	8.54E-08	6.04E-10
1794-IRT8XT	8 TC/RTD Input Analog Module	8,204,792	1.22E-07	8.66E-10

⁽¹⁾ MTBF measured in hours.

⁽²⁾ Calculated using field-based values for components

⁽³⁾ λ = Failure Rate = 1/MTBF

Table 1.4 shows an example of a PFD calculation for a safety loop involving two DC input modules used in a 1oo2 configuration and a DC output module.

Table 1.4

Catalog Number:	Description:	MTBF:	Calculated 1oo2 PFD:
1794-ACNR15	ControlNet Dual Media Adapter 1.5	3,259,605	1.56E-06
1794-IB16	24V DC Input Module	6,409,846	4.34E-06
1794-IB16	24V DC Input Module	6,409,846	4.34E-06
1794-OB16	24V DC Output Module	4,284,857	9.62E-06
1794-OW8	Relay Output Module	1,312,973	1.20E-06
1756-L63B ¹	ControlLogix Controller	2,460,065	2.33E-04
1756-CNB	ControlNet Bridge Module	3,596,087	1.15E-04
1756-CNB	ControlNet Bridge Module	3,596,087	1.15E-04
Total PFD calculation for a safety loop consisting of these products:			3.70E-04
1 See Publication 1756-RM001 for more information.			

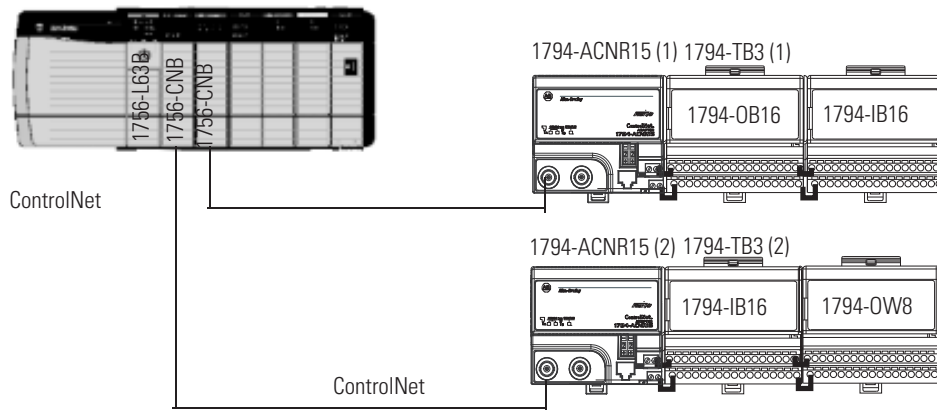

SIL Compliance Distribution and Weight

The programmable controller may conservatively be assumed to contribute 10% of the reliability burden. A SIL 2 system may need to incorporate multiple inputs for critical sensors and input devices, as well as dual outputs connected in series to dual actuators dependent on SIL assessments for the safety related system.

Response Times

The response time of the system is defined as the amount of time it takes for a change in an input condition to be recognized and processed by the controller's ladder logic program, and then to initiate the appropriate output signal to an actuator. The system response time is the sum of the following:

- input hardware delays
- input filtering
- I/O and communication module RPI settings
- controller program scan times
- output module propagation delays

See Table 1.1 for associated module information.

Each of the times listed above is variably dependent on factors such as the type of I/O module and instructions used in the ladder program. For examples of how to perform these calculations, see publication [1756-RM001](#).

Notes:

ControlLogix Communications

This chapter discusses the communication modules used in a ControlLogix SIL2 system.

For information about:	See page:
ControlNet Bridge Module	2-1
EtherNet/IP Bridge Module	2-1
Related Communications Modules Documentation	2-3

ControlNet Bridge Module

The ControlNet bridge modules (1756-CNB & 1756-CNBR) provide for the communications between ControlLogix and FLEX I/O system.

ControlNet Cabling

For remote racks, 802.3 compliant shielded or unshielded twisted pair cable is required for EtherNet/IP. Although it is not a requirement to use redundant media with the 1756-CNBR, it does provide higher system availability. Redundant media is not required for SIL2 operation.

ControlNet Module Diagnostic Coverage

All communications over the passive ControlNet media occur via CIP, which guarantees delivery of the data. All modules independently verify proper transmission of the data.

EtherNet/IP Bridge Module

The EtherNet/IP bridge modules (1756-ENBT, 1756-EN2T, 1756-EN2TR, and 1756-EN2TXT) provide for the communications between ControlLogix and FLEX I/O system.

EtherNet/IP Cabling

802.3 compliant shielded or unshielded twisted pair cable is required for EtherNet/IP.

EtherNet/IP Module Diagnostic Coverage

Communications over 10/100 MbpsNet media occur via CIP, which guarantees delivery of the data. All modules independently verify proper transmission of the data.

Module Fault Reporting for any FLEX I/O Module

To monitor the connection status for this type of connection, use a Get System Value (GSV) and an examination of MODULE objects' "Entry Status" attribute for a running connection.

An example of how this might be done is shown in Figure 2.1. This method, or something similar, must be used to interrogate the health of each I/O module in the system.

Figure 2.1 Example of Checking a Module's Health in Ladder Logic

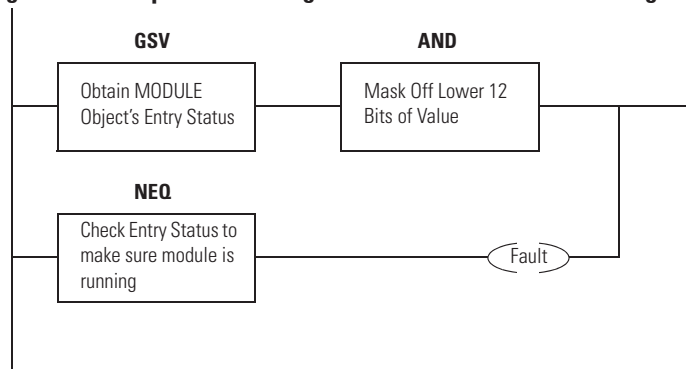

For more information on the GSV instruction, monitor the SlotStatusBits for the Input tag of the associated adapter. The lower 8 bits of this tag correspond to the associated slot. For example, the tag "Node3:I.SlotIStatusBits" is defined as follows:

NODE3 - This is the name given to the associated 1794-AVNR15.

I = This indicates the Input file.

SlotStatusBits - This is a 32 bit value. The lower 8 bits of this value are defined as follows for FLEX I/O:

Module 7	Module 6	Module 5	Module 4	Module 3	Module 2	Module 1	Module 0
-------------	-------------	-------------	-------------	-------------	-------------	-------------	-------------

Related Communications Modules Documentation

For more information on ControlLogix communications modules, see the following Rockwell Automation publications listed in Table 2.1:

Table 2.1

Catalog Number:	Description:	Installation Instructions:	User Manual:
1756-CNB	ControlNet Communication Module	1756-IN571	CNET-UM001
1756-CNBR	Redundant ControlNet Communication Module		

These publications are available from Rockwell Automation at:

<http://literature.rockwellautomation.com>.

FLEX I/O Modules

This chapter discusses the FLEX I/O modules that are SIL2 certified.

For information about:	See page:
Overview of FLEX I/O Modules	3-1
Using Digital Input Modules	3-2
Wiring FLEX I/O Digital Input Modules	3-3
General Considerations when using Any FLEX I/O Digital Output Module	3-4
Wiring FLEX I/O Digital Output Modules	3-5
Using Analog Input Modules	3-7
Wiring FLEX I/O Analog Input Modules	3-9
Checklist for SIL Inputs	3-18
Checklist for SIL Outputs	3-19

Overview of FLEX I/O Modules

In the most basic description, there are two types of SIL2-certified FLEX I/O modules:

- Digital I/O modules
- Analog I/O modules

With each type, however, there are differences between specific modules. Because the differences propagate to varying levels in each module type, a graphical representation can best provide an overview of the many SIL2-certified FLEX I/O modules.

FLEX I/O modules are designed with inherent features that assist them in complying with the requirements of the 61508 Standard. For example, the modules all have a common backplane interface, execute power-up and runtime diagnostics, and offer electronic keying.

Table 1.1 lists the FLEX I/O modules initially submitted for SIL2 certification.

Using Digital Input Modules

General Considerations when using Any FLEX I/O Digital Input Module

Regardless of the type of FLEX I/O input module used, there are a number of general application considerations that users must follow when applying these modules in a SIL2 application:

- **Proof Tests** - Periodically (for example, once every several years) a System Validation test must be performed. Manually, or automatically, test inputs to make sure that all inputs are operational and not stuck in the ON or OFF state. Inputs must be cycled from ON to OFF or OFF to ON. .
- Wire sensors to separate input points on two separate modules that are on different ControlNet nodes.
- Configuration parameters (for example, RPI, filter values) must be identical between the two modules.
- The same controller must own both modules.
- Monitor the ControlNet status bits for the associated module and ensure that appropriate action is invoked via the application logic by these status bits.

Wiring FLEX I/O Digital Input Modules

The wiring diagrams in Figure 3.1 show two methods of wiring the digital input Module. In either case, users must determine whether the use of 1 or 2 sensors is appropriate to fulfill SIL2 requirements.

Figure 3.1 ControlLogix Digital Input Module Wiring

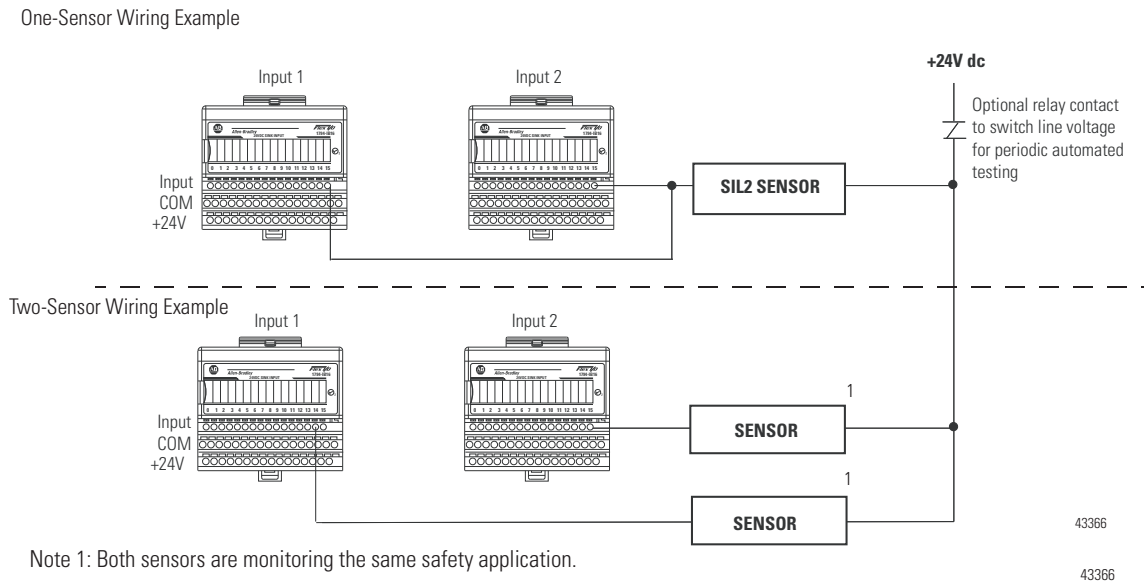

Application logic can compare input values or states for concurrence.

Figure 3.2

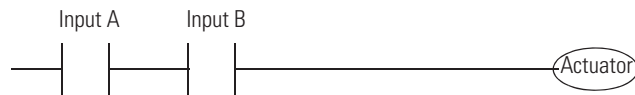

The user program must also contain rungs to annunciate a fault in the event of a sustained mismatch between two points.

Figure 3.3

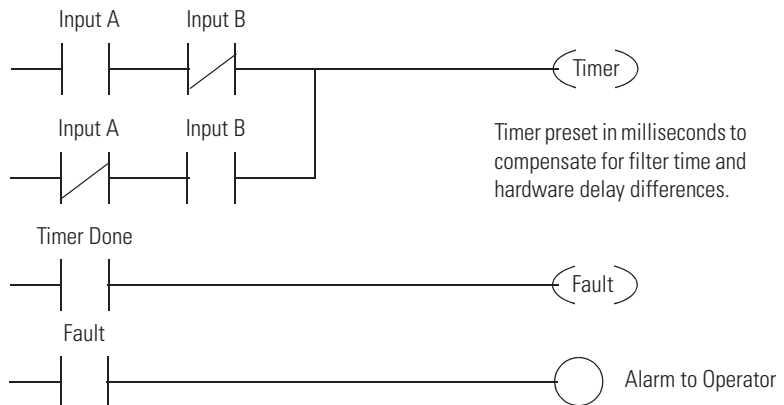

The control, diagnostics and alarming functions must be performed in sequence. For more information on faults, see publication [1756-RM001](#).

General Considerations when using Any FLEX I/O Digital Output Module

Regardless of the type of FLEX I/O output module used, there are a number of general application considerations that you must follow when applying these modules in a SIL2 application:

- **Proof Tests** - Periodically (for example, once every several years) a System Validation test must be performed. Manually, or automatically, test outputs to make sure that all outputs are operational and not stuck in the ON or OFF state. Outputs must be cycled from ON to OFF or OFF to ON. For additional information, refer to publication [1756-RM001](#).

Figure 3.4

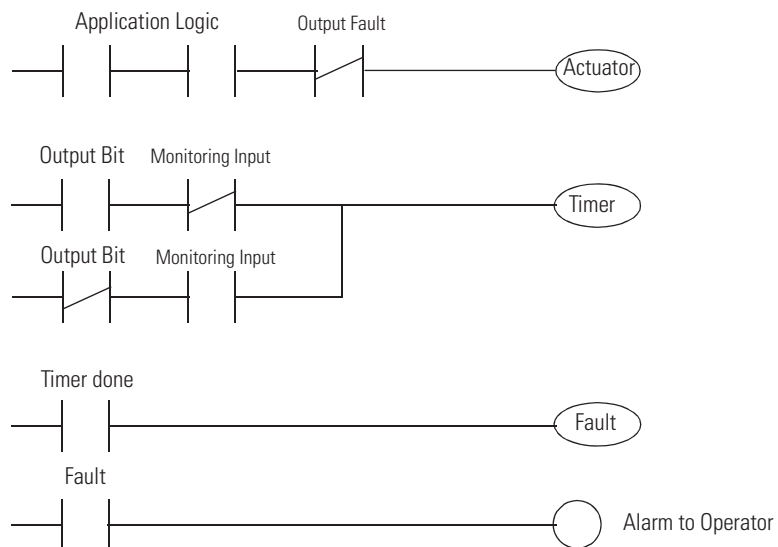

The control, diagnostics and alarming functions must be performed in sequence..

- **Use of external Relays to disconnect Module Power if Output De-energization is Critical:** To make sure outputs will de-energize, users must wire an external method that can remove power from the actuator if a short or other fault is detected.
- **Test outputs at specific times to make sure they are operating properly.** The method and frequency of testing is determined by the type of module.

- Monitor the ControlNet status bits for the associated module and ensure that appropriate action is invoked via the application logic by these status bits.

Wiring FLEX I/O Digital Output Modules

Standard Digital Output Modules

When using standard output modules, users must wire an output to an actuator and then back to an input to monitor the output's performance.

In addition to following the General Considerations when using Any FLEX I/O Digital Output Module on page 3-4, the user must wire each standard output to a corresponding input to validate that the output is following its commanded state.

Figure 3.5 ControlLogix/FLEX I/O Standard Output Module Wiring

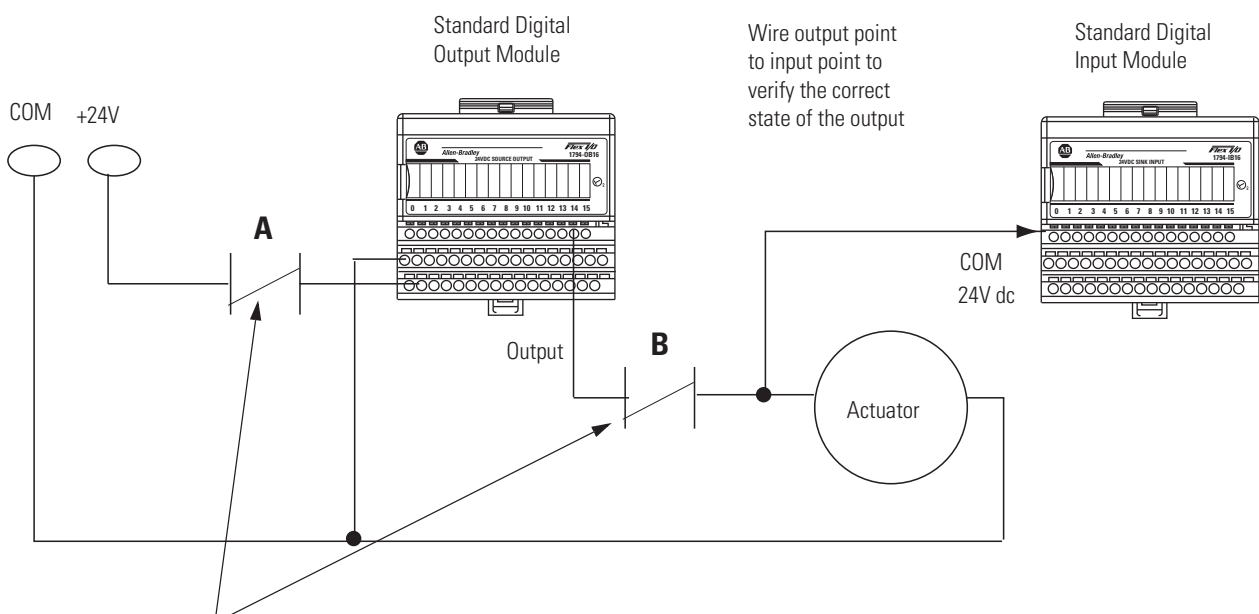

Install a relay in position A or B. This relay is controlled by another output in the ControlLogix/FLEX I/O system. If a short circuit or fault occurs on output modules, the relay can disconnect power to the modules. An isolated relay output module (1794-OW8) can be used for this purpose when it is connected to a different 1794-ACN15 or -ACNR15 ControlNet Adapter module.

Note: Other configurations are possible as long they are SIL2 approved.

43363

Application logic must be written to generate a fault in the event of a mismatch between the requested state of an output (echo) and the actual output state monitored by an input channel (see Figure 3.4).

The control, diagnostics and alarming functions must be performed in sequence.

Users can also wire a standard digital output module in series with an isolated relay output module in series with a critical actuator. In the event that a failure is detected, the output from both output modules must be set to OFF to guarantee the Output Loads de-energize. This is shown in Figure 3.6.

Figure 3.6 ControlLogix/FLEX I/O Standard Output Module Wiring With an Isolated Relay Module

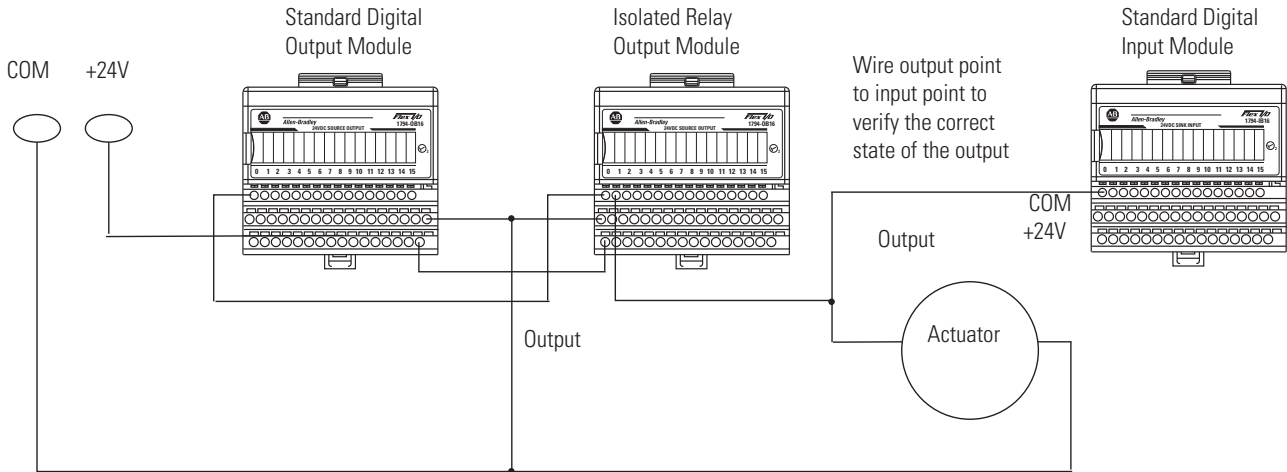

Note 1: An external relay can be replaced with an isolated relay module which is mounted in another FLEX I/O rail.

Using Analog Input Modules

General Considerations when using Any FLEX I/O Analog Input Module

There are a number of general application considerations that you must follow when applying these modules in a SIL2 application:

- **Proof Tests** - Periodically (for example, once every several years) a System Validation test must be performed. Manually, or automatically, test inputs to make sure that all inputs are operational. Field signal levels should be varied over the full operating range to make sure that the corresponding channel data varies accordingly. For additional information, refer to publication [1756-RM001](#).
- **Calibrate Inputs Periodically, As Necessary:** FLEX I/O modules ship from the factory with a highly accurate level of calibration. However, because each application is different, users are responsible for making sure their FLEX I/O modules are properly calibrated for their specific application.

Users can employ tests in application program logic to determine when a module requires recalibration. For example, to determine whether an input module needs to be recalibrated, a user can determine a tolerance band of accuracy for a specific application. The user can then measure input values on multiple channels and compare those values to acceptable values within the tolerance band. Based on the differences in the comparison, the user could then determine whether recalibration is necessary.

Calibration (and subsequent recalibration) is **not a safety issue**. However, we recommend that each analog input be calibrated at least every 3 years to verify the accuracy of the input signal and avoid nuisance application shutdowns.

- **Compare Analog Input Data and Annunciate Mismatches:** When wiring sensors to two input channels, the values from those channels must be compared to each other for concurrence within an acceptable range for the application before actuating an output. Any mismatch between the two inputs outside the programmed acceptable range must be annunciated as a fault.

In Figure 3.7, a user-defined percentage of acceptable deviation (that is, tolerance) is applied to the configured input range of the analog inputs (that is, range) and the result is stored (that is, delta). This delta value is then added to and subtracted from one of the input channels; the results define an acceptable High and Low limit of deviation. The second input channel is then compared to these limits to determine if the input are working properly.

The input's OK bit preconditions a Timer run that is preset to accommodate an acceptable fault response time and any communication filtering lags in the system. If the inputs miscompare for longer than the preset value, a fault is registered with a corresponding alarm.

Figure 3.7

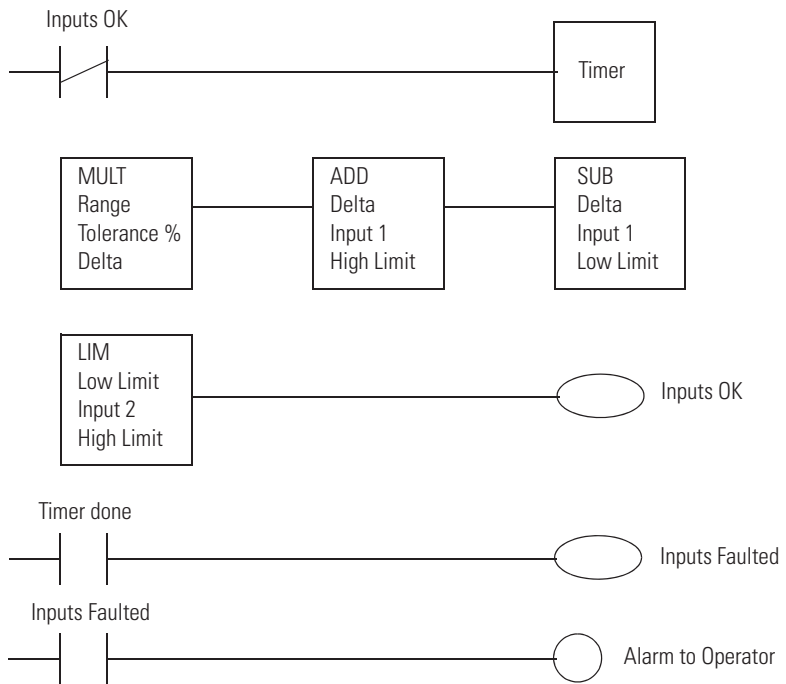

The control, diagnostics and alarming functions must be performed in sequence.

- Configuration parameters (for example, RPI, filter values) must be identical between the two modules.
- The same controller must own both modules.
- Monitor the ControlNet status bits for the associated module and ensure that appropriate action is invoked via the application logic by these status bits.
- Wire sensors to separate input channels on two separate modules that are on different ControlNet nodes.

Wiring FLEX I/O Analog Input Modules

The wiring diagrams in show two methods of wiring the analog input Module. In either case, **users must determine** whether the use of 1 or 2 sensors is appropriate to fulfill SIL2 requirements.

Figure 3.8 ControlLogix Analog Input Module Wiring

One-Sensor Wiring Example

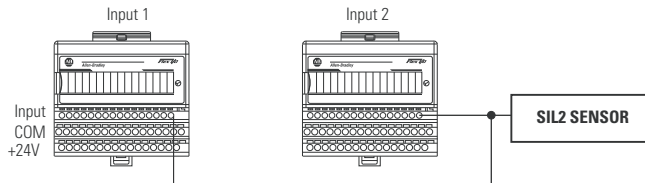

Two-Sensor Wiring Example

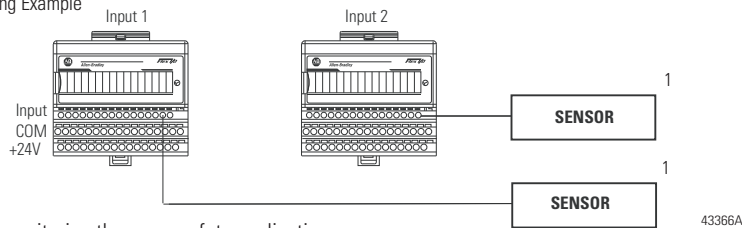

Note 1: Both sensors are monitoring the same safety application.

43366A

Wiring the Single-Ended Input Module in Voltage Mode

In addition to following the General Considerations when using Any FLEX I/O Analog Input Module on page 3-7, make sure you use the correct documentation (listed in Table 1.1 on page 1-5) to wire the module.

Figure 3.9 FLEX I/O Analog Input Module Wiring in Voltage Mode

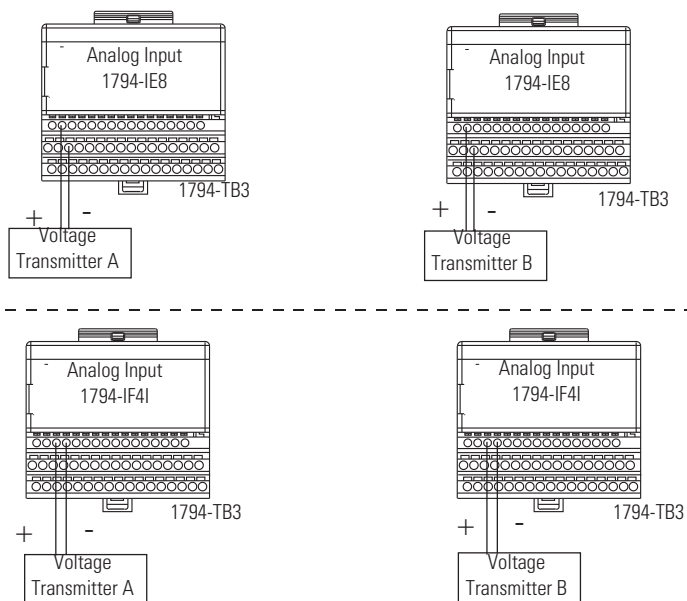

Wiring the Single-Ended Input Module in Current Mode

In addition to following the General Considerations when using Any FLEX I/O Analog Input Module on page 3-7, before wiring the module, consider the following application guideline:

- **Placement of Other Devices in Current Loop:** you can locate other devices in an input channel's current loop anywhere as long as the current source can provide sufficient voltage to accommodate all of the voltage drops (each module input is 250 ohms)

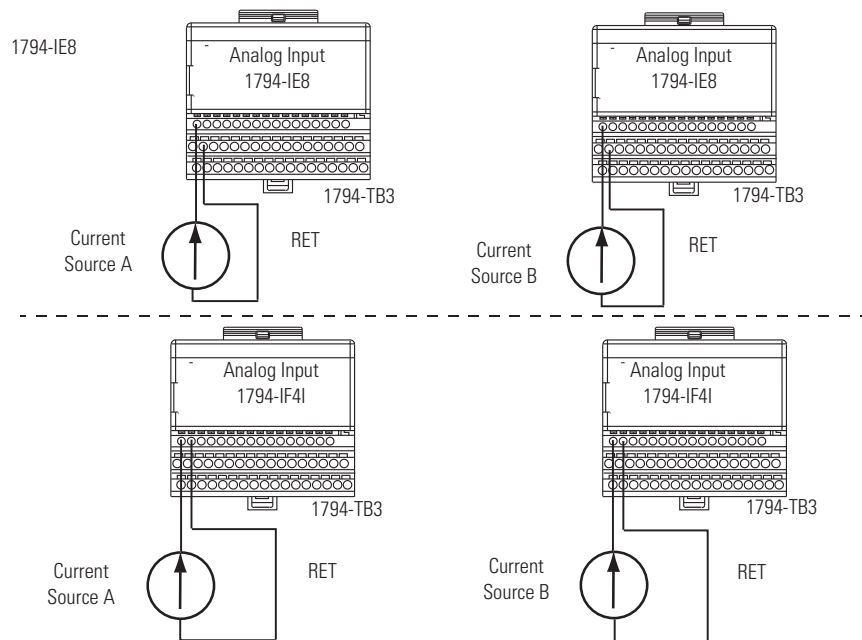

Wiring the Thermocouple Input Module

In addition to following the General Considerations when using Any FLEX I/O Analog Input Module on page 3-7, before wiring the module, consider the following application guideline:

- **Wire to Same Input Channel on Both Modules:** When wiring thermocouples, wire two in parallel to two modules. Use the same channel on each module to make sure of consistent temperature readings.

Figure 3.10 FLEX I/O Analog Thermocouple Module Wiring

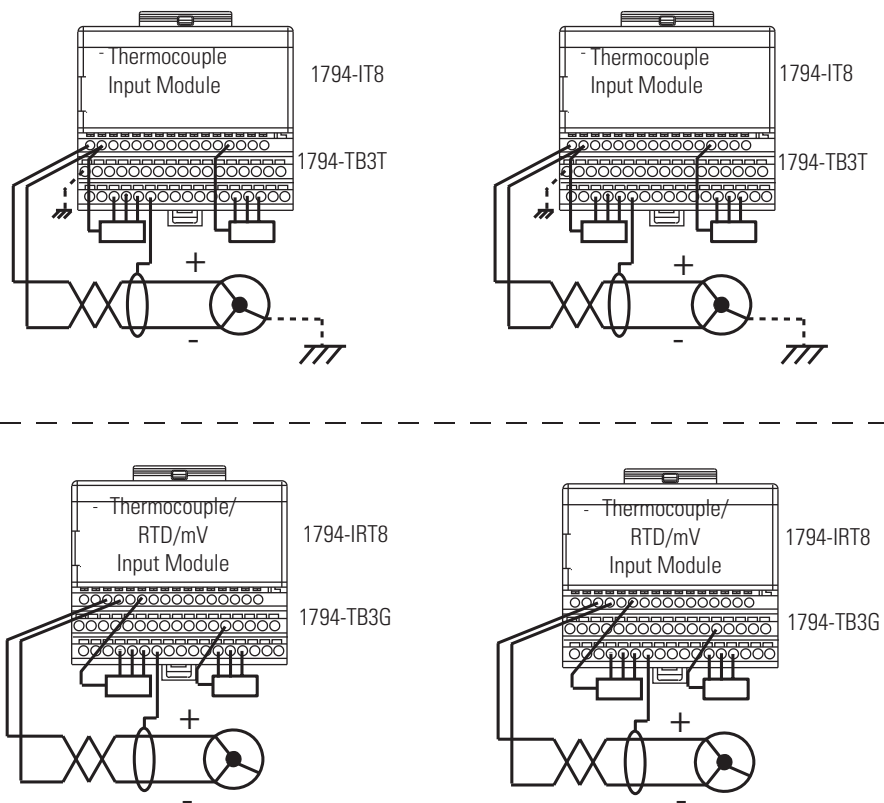

Wiring the RTD Input Module

In addition to following the General Considerations when using Any FLEX I/O Analog Input Module on page 3-7, before wiring the module, consider the following application guideline:

- RTDs cannot be wired in parallel without severely affecting their accuracy. Two sensors must be used.

Figure 3.11 FLEX I/O Analog RTD Module Wiring

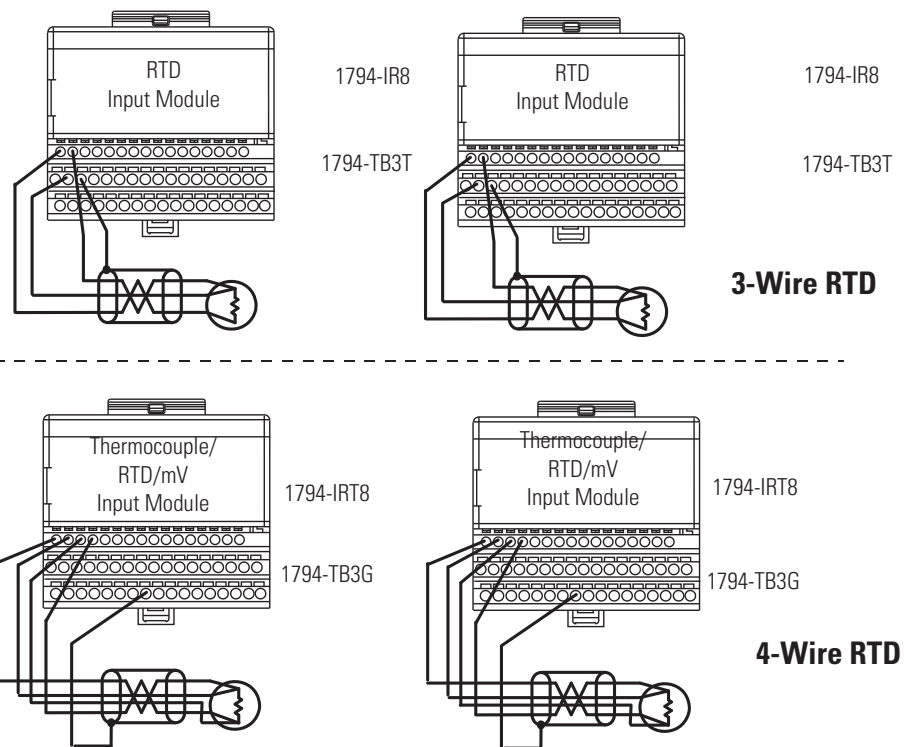

Note: 2, 3, or 4-wire RTDs can be used as applicable to the associated RTD input module.

Using Analog Output Modules

General Considerations when using Any FLEX I/O Analog Output Module

There are a number of general application considerations that you must follow when applying the analog output modules in a SIL2 application:

- **Proof Tests** - Periodically (for example, once every several years) a System Validation test must be performed. Manually, or automatically, test outputs to make sure that all outputs are operational. Channel data should be varied over the full operating range to make sure that the corresponding field signal levels vary accordingly. For additional information on , see Publication [1756-RM001](#).
- **Calibrate Outputs Periodically, As Necessary:** FLEX I/O modules ship from the factory with a highly accurate level of calibration. However, because each application is different, users are responsible for making sure their FLEX I/O modules are properly calibrated for their specific application.

Users can employ tests in application program logic to determine when a module requires recalibration. For example, to determine whether an output module needs to be recalibrated, a user can determine a tolerance band of accuracy for a specific application. The user can then measure output values on multiple channels and compare those values to acceptable values within the tolerance band. Based on the differences in the comparison, the user could then determine whether recalibration is necessary.

Calibration (and subsequent recalibration) is **not a safety issue**. However, we recommend that each analog output be calibrated at least every 3 years to verify the accuracy of the input signal and avoid nuisance application shutdowns.

- **For typical emergency shutdown (ESD) applications outputs must be configured to De-energize:** When configuring any FLEX I/O output module, each output must be configured to de-energize in the event of a fault and in the event of the controller going into program mode. For exceptions to the typical ESD applications, see publication [1756-RM001](#).

• **Wire Output Back to Input and Examination of Output Data**

Feedback signal: Users must wire an analog output to an actuator and then back to an analog input to monitor the output's performance. (The use of feedback transmitters to verify an output's performance is acceptable.) The application logic must examine the Data Feedback value associated with each output point to make sure that the requested output command from the controller was received by the module. The value must be compared to the analog input that is monitoring the output to make sure the value is in an acceptable range for the application.

In the ladder diagram in Figure 3.12, a user-defined percentage of acceptable deviation (that is, tolerance) is applied to the configured range of the analog input and output (that is, range) and the result is stored (that is, delta). This delta value is then added to and subtracted from the monitoring analog input channel; the results define an acceptable High and Low limit of deviation. The analog Output Feedback is then compared to these limits to determine if the output are working properly.

The output's OK bit preconditions a Timer run that is preset to accommodate an acceptable fault response time and any communication filtering, or output, lags in the system. If the monitoring input value and the Output Feedback mismatch for longer than the preset value, a fault is registered with a corresponding alarm.

Figure 3.12 Monitoring an Analog Output with an Analog Input

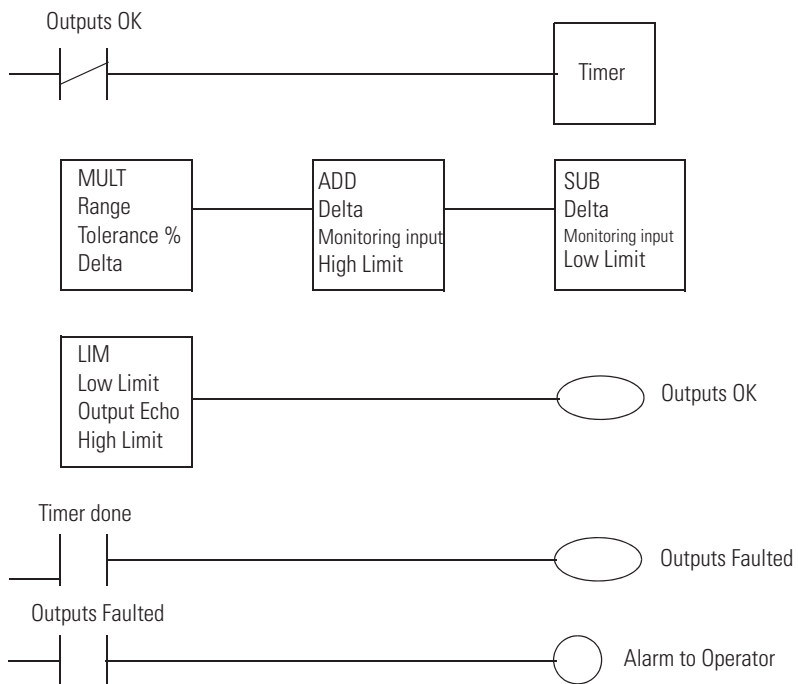

The control, diagnostics and alarming functions must be performed in sequence.

- When wiring two analog output modules in the same application, make sure:
 - Both modules use identical configuration.
 - The same controller owns both modules.
- Monitor the ControlNet status bits for the associated module and ensure that appropriate action is invoked via the application logic by these status bits.

Wiring FLEX I/O Analog Output Modules

In general, good design practice dictates that each analog output must be wired to a separate input terminal to make sure that the output is functioning properly.

Wiring the Analog Output Module in Voltage Mode

Users must wire analog outputs to an actuator and then back to an analog input to monitor the output performance.

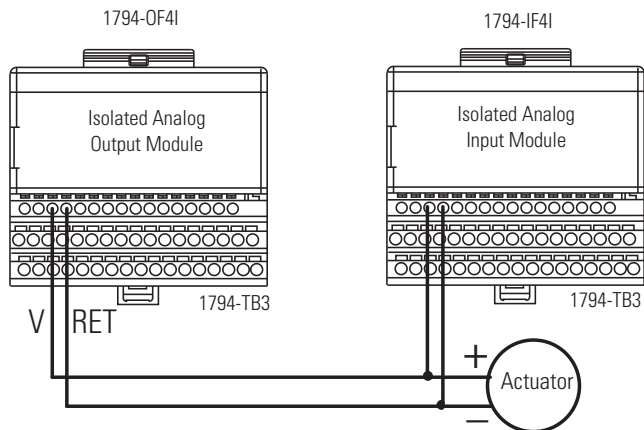
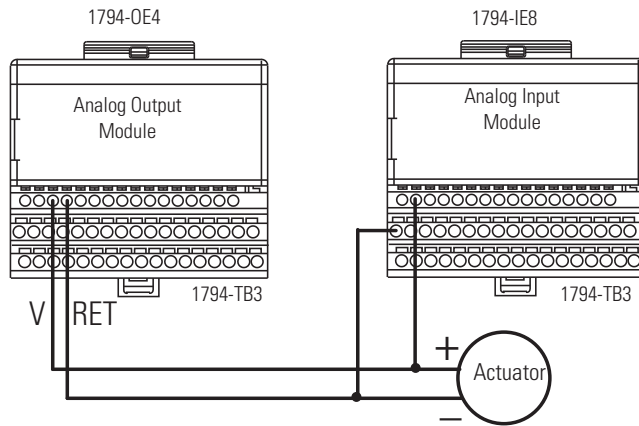

Wiring the Analog Output Module in Current Mode

In addition to following the General Considerations when using Any FLEX I/O Analog Output Module on page 3-13, consider the following application guideline before wiring the module in current mode:

- **Placement of Other Devices in Current Loop:** you can locate other devices in an output channel's current loop anywhere as long as the current source can provide sufficient voltage to accommodate all of the voltage drops.

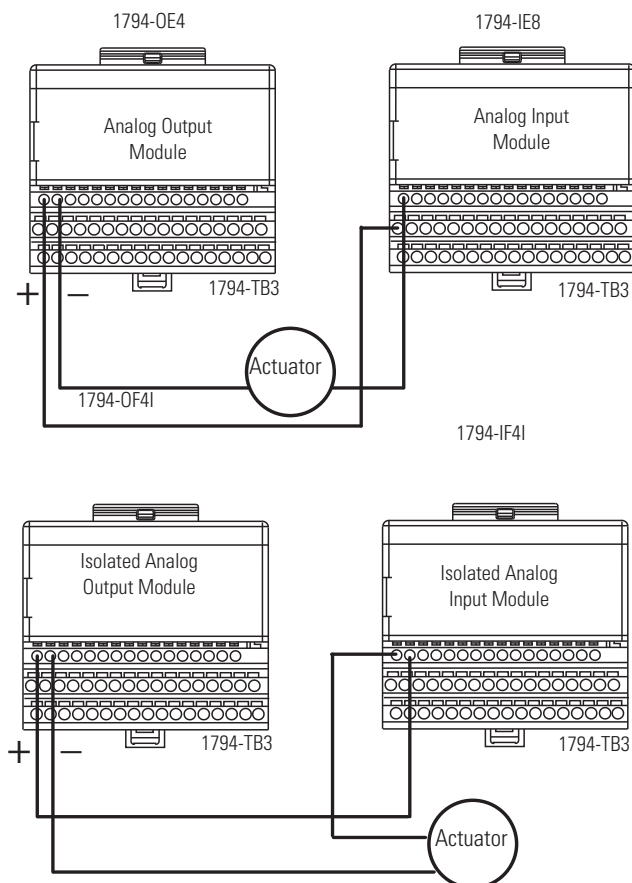

Checklist for SIL Inputs

The following checklist is required for planning, programming and start up of SIL inputs. It may be used as a planning guide as well as during proof testing. If used as a planning guide, the checklist can be saved as a record of the plan.

For programming or start-up, an individual checklist can be filled in for every single SIL input channel in a system. This is the only way to make sure that the requirements were fully and clearly implemented. This checklist can also be used as documentation on the connection of external wiring to the application program.

Input Check List for ControlLogix/FLEX I/O System

Company:

Site:

Loop definition:

SIL input channels in the:

No.	All Input Module Requirements (apply to both digital and analog input modules)	Yes	No	Comment
1	Is the RPI value set to an appropriate value for your application?	<input type="checkbox"/>	<input type="checkbox"/>	
2	Are all modules owned by the same controller?	<input type="checkbox"/>	<input type="checkbox"/>	
3	Have you performed proof tests on the system and modules?	<input type="checkbox"/>	<input type="checkbox"/>	
4	Have you set up the fault routines?	<input type="checkbox"/>	<input type="checkbox"/>	
5	Are control, diagnostics and alarming functions performed in sequence in application logic? Note: The user must ensure that the hardware series and the firmware series and revision of the FLEX I/O modules in their system are SIL2 certified.	<input type="checkbox"/>	<input type="checkbox"/>	
6	Is the application logic monitoring one ControlNet status bit for the associated module and is appropriate action invoked via the application logic by these bits?	<input type="checkbox"/>	<input type="checkbox"/>	
No.	Additional Digital Input Module-Only Requirements	Yes	No	Comment
1	When two digital input modules are wired in the same application, do the following conditions exist: <ul style="list-style-type: none"> • Both modules are owned by the same controller. • Sensors are wired to separate input points. • The operational state is ON. • The non-operational state is OFF. • Configuration parameters (for example, RPI, filter values) are identical. • Both input modules are on different ControlNet nodes. 	<input type="checkbox"/>	<input type="checkbox"/>	
2	For the standard input modules, is the Communication Format set to one of the Input Data choices?	<input type="checkbox"/>	<input type="checkbox"/>	
No.	Additional Analog Input Module-Only Requirements	Yes	No	Comment
1	Have you calibrated the modules as often as required by your application?	<input type="checkbox"/>	<input type="checkbox"/>	
2	Are you using ladder logic to compare the analog input data on two channels to make sure there is concurrence within an acceptable range and that redundant data is used properly?	<input type="checkbox"/>	<input type="checkbox"/>	
3	Have you written application logic to examine bits for any condition that may cause a fault and appropriate fault routines to handle the fault condition?	<input type="checkbox"/>	<input type="checkbox"/>	
4	When wiring the FLEX I/O analog module in voltage mode, are transmitter connections wired correctly?	<input type="checkbox"/>	<input type="checkbox"/>	
5	When wiring the FLEX I/O analog module in current mode, are loop devices placed properly?	<input type="checkbox"/>	<input type="checkbox"/>	
6	When wiring FLEX I/O thermocouple modules in parallel, have you wired to the same channel on each module?	<input type="checkbox"/>	<input type="checkbox"/>	
7	When wiring two FLEX I/O RTD modules, are two sensors used?	<input type="checkbox"/>	<input type="checkbox"/>	
8	When two analog inputs are wired in the same application, are both modules on different ControlNet Nodes?	<input type="checkbox"/>	<input type="checkbox"/>	

Checklist for SIL Outputs

The following checklist is required for planning, programming and start up of SIL outputs. It may be used as a planning guide as well as during proof testing. If used as a planning guide, the checklist can be saved as a record of the plan.

For programming or start-up, an individual requirement checklist must be filled in for every single SIL output channel in a system. This is the only way to make sure that the requirements are fully and clearly implemented. This checklist can also be used as documentation on the connection of external wiring to the application program.

Output Check List for ControlLogix/FLEX I/O System

Company:

Site:

Loop definition:

SIL output channels in the:

No.	All Output Module Requirements (apply to both digital and analog output modules)	Yes	No	Comment:
1	Have you performed proof tests on the modules?	<input type="checkbox"/>	<input type="checkbox"/>	
2	Is the RPI value set to an appropriate value for your application?	<input type="checkbox"/>	<input type="checkbox"/>	
3	Have you set up fault routines, including comparing output data with a corresponding input point?	<input type="checkbox"/>	<input type="checkbox"/>	
4	If required, have you used external relays in your application to disconnect module power if a short or other fault is detected on the module or isolated output in series?	<input type="checkbox"/>	<input type="checkbox"/>	
5	Is the control of the external relay implemented in ladder logic?	<input type="checkbox"/>	<input type="checkbox"/>	
6	Have you examined the Output Data feedback signal in application logic?	<input type="checkbox"/>	<input type="checkbox"/>	
7	Are all outputs configured to deenergize in the event of a fault or the controller entering program mode?	<input type="checkbox"/>	<input type="checkbox"/>	
8	Do two modules of the same type, used in the same application, use identical configurations?	<input type="checkbox"/>	<input type="checkbox"/>	
9	Does one controller own both modules if two of the same type are used in an application?	<input type="checkbox"/>	<input type="checkbox"/>	
10	Are control, diagnostics and alarming functions performed in sequence in application logic?	<input type="checkbox"/>	<input type="checkbox"/>	
11	Is the application logic monitoring one ControlNet status bit for the associated module and is appropriate action invoked via the application logic by these bits?	<input type="checkbox"/>	<input type="checkbox"/>	
No.	Digital Output Module-Only Requirements	Yes	No	Comment
1	For the standard output modules, is the Communication Format set to Output Data?	<input type="checkbox"/>	<input type="checkbox"/>	
2	For standard output modules, have you wired the outputs to a corresponding input to validate that the output is following its commanded state?	<input type="checkbox"/>	<input type="checkbox"/>	
No.	Analog Output Module-Only Requirements	Yes	No	Comment
1	Have you calibrated the modules as often as required by your application?	<input type="checkbox"/>	<input type="checkbox"/>	
2	When wiring the FLEX I/O analog output module in current mode, are loop devices placed properly?	<input type="checkbox"/>	<input type="checkbox"/>	
3	Have you written application logic to examine bits for any condition that may cause a fault and appropriate fault routines to handle the fault condition?	<input type="checkbox"/>	<input type="checkbox"/>	

Notes:

General Requirements for Application Software

Refer to publication [1756-RM001](#), Using ControlLogix in SIL2 Applications.

Notes:

Technical SIL2 Requirements for the Application Program

Refer to publication [1756-RM001](#) for Technical SIL2 Requirements for the application program.

Notes:

Failure Estimates

The following tables list the failure estimates for the FLEX I/O products included in this manual for different proof test intervals.

Table A.1 MTBF Field Data and Per Module PFD Estimates - $T_1 = 1$ year

Catalog Number:	Description:	(MTBF) ⁽¹⁾	λ ⁽³⁾	Estimated PFD 1oo2
1794-ACN15	ControlNet Single Media Adapter	8,223,684	1.22E-07	2.15E-06
1794-ACNR15	ControlNet Redundant Media Adapter	8,223,684	1.22E-07	2.15E-06
1794-AENT	10/100Mb Ethernet Communication Adapter	691,134	1.45E-06	2.76E-05
1794-AENTR	10/100Mb Ethernet Redundant Communication Adapter	1,268,070	7.89E-07	1.45E-05
1794-IB10XOB6	10 Input/6 Output Module	4,943,442	2.02E-07	3.60E-06
1794-IB16	16 Sink Input Module	4,105,090	2.44E-07	4.34E-06
1794-IE8	Analog Input Module	37,952,679	2.63E-08	4.64E-07
1794-IF2XOF2I	Isolated Analog Input/Output Module	25,296,960	3.95E-08	6.97E-07
1794-IF4I	Isolated Analog Input Module	11,746,343	8.51E-08	1.50E-06
1794-IJ2	Frequency Counter Module	2,418,321	4.14E-07	7.45E-06
1794-IP4	Pulse Counter Module	2,375,360	4.21E-07	7.58E-06
1794-IR8	RTD Input Module	6,191,655	1.62E-07	2.87E-06
1794-IRT8	TC/RTD/mV Input Module	1,182,438	8.46E-07	1.56E-05
1794-IT8	Thermocouple Input Module	1,564,324	6.39E-07	1.17E-05
1794-OB16	16 Source Output Module	1,883,594	5.31E-07	9.62E-06
1794-OB16P	Protected Output Module	2,135,280	4.68E-07	8.46E-06
1794-OB8EP	Protected Output Module	2,389,669 ⁽²⁾	4.18E-07	7.54E-06
1794-OE4	Analog Output Module	23,807,086	4.20E-08	7.41E-07
1794-OF4I	Isolated Analog Output Module	7,191,128	1.39E-07	2.47E-06
1794-OW8	Relay Output Module	14,766,876	6.77E-08	1.20E-06
1794-TB3	Terminal Base Units	21,128,346 ⁽²⁾	4.73E-08	8.35E-07
1794-TB3G	Generic Terminal Base Units	27,320,800	3.66E-08	6.45E-07
1794-TB3GS	Generic Terminal Base Units	46,425,600	2.15E-08	3.79E-07
1794-TB3S	Terminal Base Unit	71,433,747 ⁽²⁾	1.40E-08	2.46E-07
1794-TB3T	Temperature Terminal Base Units	73,096,226 ⁽²⁾	1.37E-08	2.41E-07
1794-TB3TS	Temperature Terminal Base Units	75,763,399 ⁽²⁾	1.32E-08	2.32E-07
1794-TBN	Terminal Base Units	75,716,615	1.32E-08	2.32E-07
1794-TBNF	Fused Terminal Base Units	4,812,320 ⁽²⁾	2.08E-07	3.70E-06
1794-ACNR15XT	ControlNet Redundant Media Adapter	8,223,684	1.22E-07	2.15E-06

Table A.1 MTBF Field Data and Per Module PFD Estimates - $T_1 = 1$ year

Catalog Number:	Description:	(MTBF) ⁽¹⁾	λ ⁽³⁾	Estimated PFD 1002
1794-AENTRXT	10/100Mb Ethernet Redundant Communication Adapter	1,268,070	7.89E-07	1.45E-05
1794-OB8EPXT	8 Protected Output Module	14,771,049	6.77E-08	1.20E-06
1794-IB16XT	16 Sink Input Module	35,587,189	2.81E-08	4.95E-07
1794-OB16PXT	16 Protected Output Module	26,709,401	3.74E-08	6.60E-07
1794-IB10XOB6XT	10 Input/6 Output Combo Module	22,202,487	4.50E-08	7.94E-07
1794-OW8XT	8 Relay Output Module	18,518,519	5.40E-08	9.53E-07
1794-IE4XOE2XT	4 Input/2 Output Analog Combo Module	11,800,802	8.47E-08	1.50E-06
1794-IE8XT	8 Input analog Module	14,041,000	7.12E-08	1.26E-06
1794-OE4XT	4 Output Analog Module	11,381,744	8.79E-08	1.55E-06
1794-IF2XOF2IXT	2 Input/2 Output Isolated Analog Combo Module	6,317,918	1.58E-07	2.81E-06
1794-IF4IXT	4 Isolated Input Analog Module	7,297,140	1.37E-07	2.43E-06
1794-IF4ICFXT	4 Isolated Input Analog Module	7,297,140	1.37E-07	2.43E-06
1794-OF4IXT	4 Isolated Output Analog Module	5,493,902	1.82E-07	3.24E-06
1794-IJ2XT	2 Ch. Frequency Counter Module	11,714,128	8.54E-08	1.51E-06
1794-IRT8XT	8 TC/RTD Input Analog Module	8,204,792	1.22E-07	2.16E-06

⁽¹⁾ MTBF measured in hours.

⁽²⁾ Calculated using field-based values for components

⁽³⁾ λ = Failure Rate = 1 / MTBF

Table A.2 MTBF Field Data and Per Module PFD Estimates - $T_1 = 2$ years

Catalog Number:	Description:	(MTBF) ⁽¹⁾	λ ⁽³⁾	Estimated PFD 1002
1794-ACN15	ControlNet Single Media Adapter	8,223,684	1.22E-07	4.33E-06
1794-ACNR15	ControlNet Redundant Media Adapter	8,223,684	1.22E-07	4.33E-06
1794-AENT	10/100Mb Ethernet Communication Adapter	691,134	1.45E-06	5.92E-05
1794-AENTR	10/100Mb Ethernet Redundant Communication Adapter	1,268,070	7.89E-07	3.02E-05
1794-IB10XOB6	10 Input/6 Output Module	4,943,442	2.02E-07	7.27E-06
1794-IB16	16 Sink Input Module	4,105,090	2.44E-07	8.79E-06
1794-IE8	Analog Input Module	37,952,679	2.63E-08	9.28E-07
1794-IF2XOF2I	Isolated Analog Input/Output Module	25,296,960	3.95E-08	1.39E-06
1794-IF4I	Isolated Analog Input Module	11,746,343	8.51E-08	3.02E-06
1794-IJ2	Frequency Counter Module	2,418,321	4.14E-07	1.52E-05
1794-IP4	Pulse Counter Module	2,375,360	4.21E-07	1.55E-05
1794-IR8	RTD Input Module	6,191,655	1.62E-07	5.77E-06
1794-IRT8	TC/RTD/mV Input Module	1,182,438	8.46E-07	3.26E-05

Table A.2 MTBF Field Data and Per Module PFD Estimates - $T_1 = 2$ years

Catalog Number:	Description:	(MTBF)⁽¹⁾	λ ⁽³⁾	Estimated PFD 1oo2
1794-IT8	Thermocouple Input Module	1,564,324	6.39E-07	2.41E-05
1794-OB16	16 Source Output Module	1,883,594	5.31E-07	1.98E-05
1794-OB16P	Protected Output Module	2,135,280	4.68E-07	1.73E-05
1794-OB8EP	Protected Output Module	2,389,669 ⁽²⁾	4.18E-07	1.54E-05
1794-OE4	Analog Output Module	23,807,086	4.20E-08	1.48E-06
1794-OF4I	Isolated Analog Output Module	7,191,128	1.39E-07	4.96E-06
1794-OW8	Relay Output Module	14,766,876	6.77E-08	2.40E-06
1794-TB3	Terminal Base Units	21,128,346 ⁽²⁾	4.73E-08	1.67E-06
1794-TB3G	Generic Terminal Base Units	27,320,800	3.66E-08	1.29E-06
1794-TB3GS	Generic Terminal Base Units	46,425,600	2.15E-08	7.58E-07
1794-TB3S	Terminal Base Unit	71,433,747 ⁽²⁾	1.40E-08	4.92E-07
1794-TB3T	Temperature Terminal Base Units	73,096,226 ⁽²⁾	1.37E-08	4.81E-07
1794-TB3TS	Temperature Terminal Base Units	75,763,399 ⁽²⁾	1.32E-08	4.64E-07
1794-TBN	Terminal Base Units	75,716,615	1.32E-08	4.64E-07
1794-TBNF	Fused Terminal Base Units	4,812,320 ⁽²⁾	2.08E-07	7.47E-06
1794-ACNR15XT	ControlNet Redundant Media Adapter	8,223,684	1.22E-07	4.33E-06
1794-AENTRXT	10/100Mb Ethernet Redundant Communication Adapter	1,268,070	7.89E-07	3.02E-05
1794-OB8EPXT	8 Protected Output Module	14,771,049	6.77E-08	2.40E-06
1794-IB16XT	16 Sink Input Module	35,587,189	2.81E-08	9.90E-07
1794-OB16PXT	16 Protected Output Module	26,709,401	3.74E-08	1.32E-06
1794-IB10XOB6XT	10 Input/6 Output Combo Module	22,202,487	4.50E-08	1.59E-06
1794-OW8XT	8 Relay Output Module	18,518,519	5.40E-08	1.91E-06
1794-IE4XOE2XT	4 Input/2 Output Analog Combo Module	11,800,802	8.47E-08	3.00E-06
1794-IE8XT	8 Input analog Module	14,041,000	7.12E-08	2.52E-06
1794-OE4XT	4 Output Analog Module	11,381,744	8.79E-08	3.12E-06
1794-IF2XOF2IXT	2 Input/2 Output Isolated Analog Combo Module	6,317,918	1.58E-07	5.66E-06
1794-IF4IXT	4 Isolated Input Analog Module	7,297,140	1.37E-07	4.89E-06
1794-IF4ICFXT	4 Isolated Input Analog Module	7,297,140	1.37E-07	4.89E-06
1794-OF4IXT	4 Isolated Output Analog Module	5,493,902	1.82E-07	6.52E-06
1794-IJ2XT	2 Ch. Frequency Counter Module	11,714,128	8.54E-08	3.03E-06
1794-IRT8XT	8 TC/RTD Input Analog Module	8,204,792	1.22E-07	4.34E-06

(1) MTBF measured in hours.

(2) Calculated using field-based values for components

(3) λ = Failure Rate = 1 / MTB

Table A.3 MTBF Field Data and Per Module PFD Estimates - $T_1 = 5$ years

Catalog Number:	Description:	(MTBF)⁽¹⁾	λ ⁽³⁾	Estimated PFD 1oo2
1794-ACN15	ControlNet Single Media Adapter	8,223,684	1.22E-07	1.10E-05
1794-ACNR15	ControlNet Redundant Media Adapter	8,223,684	1.22E-07	1.10E-05
1794-AENT	10/100Mb Ethernet Communication Adapter	691,134	1.45E-06	1.79E-04
1794-AENTR	10/100Mb Ethernet Redundant Communication Adapter	1,268,070	7.89E-07	8.47E-05
1794-IB10XOB6	10 Input/6 Output Module	4,943,442	2.02E-07	1.88E-05
1794-IB16	16 Sink Input Module	4,105,090	2.44E-07	2.28E-05
1794-IE8	Analog Input Module	37,952,679	2.63E-08	2.33E-06
1794-IF2XOF2I	Isolated Analog Input/Output Module	25,296,960	3.95E-08	3.50E-06
1794-IF4I	Isolated Analog Input Module	11,746,343	8.51E-08	7.64E-06
1794-IJ2	Frequency Counter Module	2,418,321	4.14E-07	4.05E-05
1794-IP4	Pulse Counter Module	2,375,360	4.21E-07	4.13E-05
1794-IR8	RTD Input Module	6,191,655	1.62E-07	1.48E-05
1794-IRT8	TC/RTD/mV Input Module	1,182,438	8.46E-07	9.19E-05
1794-IT8	Thermocouple Input Module	1,564,324	6.39E-07	6.62E-05
1794-OB16	16 Source Output Module	1,883,594	5.31E-07	5.36E-05
1794-OB16P	Protected Output Module	2,135,280	4.68E-07	4.65E-05
1794-OB8EP	Protected Output Module	2,389,669 ⁽²⁾	4.18E-07	4.10E-05
1794-OE4	Analog Output Module	23,807,086	4.20E-08	3.73E-06
1794-OF4I	Isolated Analog Output Module	7,191,128	1.39E-07	1.27E-05
1794-OW8	Relay Output Module	14,766,876	6.77E-08	6.05E-06
1794-TB3	Terminal Base Units	21,128,346 ⁽²⁾	4.73E-08	4.21E-06
1794-TB3G	Generic Terminal Base Units	27,320,800	3.66E-08	3.24E-06
1794-TB3GS	Generic Terminal Base Units	46,425,600	2.15E-08	1.90E-06
1794-TB3S	Terminal Base Unit	71,433,747 ⁽²⁾	1.40E-08	1.23E-06
1794-TB3T	Temperature Terminal Base Units	73,096,226 ⁽²⁾	1.37E-08	1.20E-06
1794-TB3TS	Temperature Terminal Base Units	75,763,399 ⁽²⁾	1.32E-08	1.16E-06
1794-TBN	Terminal Base Units	75,716,615	1.32E-08	1.16E-06
1794-TBNF	Fused Terminal Base Units	4,812,320 ⁽²⁾	2.08E-07	1.93E-05
1794-ACNR15XT	ControlNet Redundant Media Adapter	8,223,684	1.22E-07	1.10E-05
1794-AENTRXT	10/100Mb Ethernet Redundant Communication Adapter	1,268,070	7.89E-07	8.47E-05
1794-OB8EPXT	8 Protected Output Module	14,771,049	6.77E-08	6.05E-06
1794-IB16XT	16 Sink Input Module	35,587,189	2.81E-08	2.48E-06
1794-OB16PXT	16 Protected Output Module	26,709,401	3.74E-08	3.32E-06

Table A.3 MTBF Field Data and Per Module PFD Estimates - $T_1 = 5$ years

Catalog Number:	Description:	(MTBF) ⁽¹⁾	λ ⁽³⁾	Estimated PFD 1oo2
1794-IB10XOB6XT	10 Input/6 Output Combo Module	22,202,487	4.50E-08	4.00E-06
1794-OW8XT	8 Relay Output Module	18,518,519	5.40E-08	4.81E-06
1794-IE4XOE2XT	4 Input/2 Output Analog Combo Module	11,800,802	8.47E-08	7.61E-06
1794-IE8XT	8 Input analog Module	14,041,000	7.12E-08	6.37E-06
1794-OE4XT	4 Output Analog Module	11,381,744	8.79E-08	7.89E-06
1794-IF2XOF2IXT	2 Input/2 Output Isolated Analog Combo Module	6,317,918	1.58E-07	1.45E-05
1794-IF4IXT	4 Isolated Input Analog Module	7,297,140	1.37E-07	1.25E-05
1794-IF4ICFXT	4 Isolated Input Analog Module	7,297,140	1.37E-07	1.25E-05
1794-OF4IXT	4 Isolated Output Analog Module	5,493,902	1.82E-07	1.68E-05
1794-IJ2XT	2 Ch. Frequency Counter Module	11,714,128	8.54E-08	7.67E-06
1794-IRT8XT	8 TC/RTD Input Analog Module	8,204,792	1.22E-07	1.11E-05

⁽¹⁾ MTBF measured in hours.

⁽²⁾ Calculated using field-based values for components

⁽³⁾ λ = Failure Rate = 1 / MTBF

Table A.4 MTBF Field Data and Per Module PFH Estimates - $T_1 = 1$ year

Catalog Number:	Description:	(MTBF) ⁽¹⁾	λ ⁽³⁾	Estimated PFH 1oo2
1794-ACN15	ControlNet Single Media Adapter	8,223,684	1.22E-07	8.64E-10
1794-ACNR15	ControlNet Redundant Media Adapter	8,223,684	1.22E-07	8.64E-10
1794-AENT	10/100Mb Ethernet Communication Adapter	691,134	1.45E-06	1.19E-08
1794-AENTR	10/100Mb Ethernet Redundant Communication Adapter	1,268,070 ⁽²⁾	7.89E-07	6.05E-09
1794-IB10XOB6	10 Input/6 Output Module	4,943,442	2.02E-07	1.45E09
1794-IB16	16 Sink Input Module	4,105,090	2.44E-07	1.76E-09
1794-IE8	Analog Input Module	37,952,679	2.63E-08	1.85E-10
1794-IF2XOF2I	Isolated Analog Input/Output Module	25,296,960	3.95E-08	2.78E-10
1794-IF4I	Isolated Analog Input Module	11,746,343	8.51E-08	6.02E-10
1794-IJ2	Frequency Counter Module	2,418,321	4.14E-07	3.04E09
1794-IP4	Pulse Counter Module	2,375,360	4.21E-07	3.10E09
1794-IR8	RTD Input Module	6,191,655	1.62E-07	1.15E-09
1794-IRT8	TC/RTD/mV Input Module	1,182,438	8.46E-07	6.53E-09
1794-IT8	Thermocouple Input Module	1,564,324	6.39E-07	4.82E-09
1794-OB16	16 Source Output Module	1,883,594	5.31E-07	3.96E-09
1794-OB16P	Protected Output Module	2,135,280	4.68E-07	3.47E09
1794-OB8EP	Protected Output Module	2,389,669 ⁽²⁾	4.18E-07	3.08E09

Table A.4 MTBF Field Data and Per Module PFH Estimates - $T_1 = 1$ year

Catalog Number:	Description:	(MTBF)⁽¹⁾	λ ⁽³⁾	Estimated PFH 1oo2
1794-OE4	Analog Output Module	23,807,086	4.20E-08	2.96E-10
1794-OF4I	Isolated Analog Output Module	7,191,128	1.39E-07	9.90E10
1794-OW8	Relay Output Module	14,766,876	6.77E-08	4.78E-10
1794-TB3	Terminal Base Units	21,128,346 ⁽²⁾	4.73E-08	3.33E10
1794-TB3G	Generic Terminal Base Units	27,320,800	3.66E-08	2.57E10
1794-TB3GS	Generic Terminal Base Units	46,425,600	2.15E-08	1.51E10
1794-TB3S	Terminal Base Unit	71,433,747 ⁽²⁾	1.40E-08	9.82E11
1794-TB3T	Temperature Terminal Base Units	73,096,226 ⁽²⁾	1.37E-08	9.59E11
1794-TB3TS	Temperature Terminal Base Units	75,763,399 ⁽²⁾	1.32E-08	9.25E11
1794-TBN	Terminal Base Units	75,716,615	1.32E-08	9.26E-11
1794-TBNF	Fused Terminal Base Units	4,812,320 ⁽²⁾	2.08E-07	1.49E09
1794-ACNR15XT	ControlNet Redundant Media Adapter	8,223,684	1.22E-07	8.64E-10
1794-AENTRXT	10/100Mb Ethernet Redundant Communication Adapter	1,268,070 ⁽²⁾	7.89E-07	6.05E-09
1794-OB8EPXT	8 Protected Output Module	14,771,049	6.77E-08	4.78E-10
1794-IB16XT	16 Sink Input Module	35,587,189	2.81E-08	1.97E-10
1794-OB16PXT	16 Protected Output Module	26,709,401	3.74E-08	2.63E-10
1794-IB10XOB6XT	10 Input/6 Output Combo Module	22,202,487	4.50E-08	3.17E-10
1794-OW8XT	8 Relay Output Module	18,518,519	5.40E-08	3.80E-10
1794-IE4XOE2XT	4 Input/2 Output Analog Combo Module	11,800,802	8.47E-08	5.99E-10
1794-IE8XT	8 Input analog Module	14,041,000	7.12E-08	5.03E-10
1794-OE4XT	4 Output Analog Module	11,381,744	8.79E-08	6.22E-10
1794-IF2XOF2IXT	2 Input/2 Output Isolated Analog Combo Module	6,317,918	1.58E-07	1.13E-09
1794-IF4IXT	4 Isolated Input Analog Module	7,297,140	1.37E-07	9.75E-10
1794-IF4ICFXT	4 Isolated Input Analog Module	7,297,140	1.37E-07	9.75E-10
1794-OF4IXT	4 Isolated Output Analog Module	5,493,902	1.82E-07	1.30E-09
1794-IJ2XT	2 Ch. Frequency Counter Module	11,714,128	8.54E-08	6.04E-10

⁽¹⁾ MTBF measured in hours.

⁽²⁾ Calculated using field-based values for components

⁽³⁾ λ = Failure Rate = 1 / MTBF

Table A.5 MTBF Field Data and Per Module PFH Estimates - $T_1 = 2$ years

Catalog Number:	Description:	(MTBF) ⁽¹⁾	λ ⁽³⁾	Estimated PFH 1oo2
1794-ACN15	ControlNet Single Media Adapter	8,223,684	1.22E-07	8.76E-10
1794-ACNR15	ControlNet Redundant Media Adapter	8,223,684	1.22E-07	8.76E-10
1794-AENT	10/100Mb Ethernet Communication Adapter	691,134	1.45E-06	6.58E-09
1794-AENTR	10/100Mb Ethernet Redundant Communication Adapter	1,268,070	7.89E-07	6.58E-09
1794-IB10XOB6	10 Input/6 Output Module	4,943,442	2.02E-07	1.49E-09
1794-IB16	16 Sink Input Module	4,105,090	2.44E-07	1.81E-09
1794-IE8	Analog Input Module	37,952,679	2.63E-08	1.86E-10
1794-IF2XOF2I	Isolated Analog Input/Output Module	25,296,960	3.95E-08	2.79E-10
1794-IF4I	Isolated Analog Input Module	11,746,343	8.51E-08	6.08E-10
1794-IJ2	Frequency Counter Module	2,418,321	4.14E-07	3.19E-09
1794-IP4	Pulse Counter Module	2,375,360	4.21E-07	3.25E-09
1794-IR8	RTD Input Module	6,191,655	1.62E-07	1.18E-09
1794-IRT8	TC/RTD/mV Input Module	1,182,438	8.46E-07	7.14E-09
1794-IT8	Thermocouple Input Module	1,564,324	6.39E-07	5.17E-09
1794-OB16	16 Source Output Module	1,883,594	5.31E-07	4.20E-09
1794-OB16P	Protected Output Module	2,135,280	4.68E-07	3.65E-09
1794-OB8EP	Protected Output Module	2,389,669 ⁽²⁾	4.18E-07	3.23E-09
1794-OE4	Analog Output Module	23,807,086	4.20E-08	2.97E-10
1794-OF4I	Isolated Analog Output Module	7,191,128	1.39E-07	1.01E-09
1794-OW8	Relay Output Module	14,766,876	6.77E-08	4.82E-10
1794-TB3	Terminal Base Units	21,128,346 ⁽²⁾	4.73E-08	3.35E-10
1794-TB3G	Generic Terminal Base Units	27,320,800	3.66E-08	2.59E-10
1794-TB3GS	Generic Terminal Base Units	46,425,600	2.15E-08	1.52E-10
1794-TB3S	Terminal Base Unit	71,433,747 ⁽²⁾	1.40E-08	9.83E-11
1794-TB3T	Temperature Terminal Base Units	73,096,226 ⁽²⁾	1.37E-08	9.61E-11
1794-TB3TS	Temperature Terminal Base Units	75,763,399 ⁽²⁾	1.32E-08	9.27E-11
1794-TBN	Terminal Base Units	75,716,615	1.32E-08	9.27E-11
1794-TBNF	Fused Terminal Base Units	4,812,320 ⁽²⁾	2.08E-07	1.53E-09
1794-ACNR15XT	ControlNet Redundant Media Adapter	8,223,684	1.22E-07	8.76E-10
1794-AENTRXT	10/100Mb Ethernet Redundant Communication Adapter	1,268,070	7.89E-07	6.58E-09
1794-OB8EPXT	8 Protected Output Module	14,771,049	6.77E-08	4.82E-10
1794-IB16XT	16 Sink Input Module	35,587,189	2.81E-08	1.98E-10
1794-OB16PXT	16 Protected Output Module	26,709,401	3.74E-08	2.64E-10

Table A.5 MTBF Field Data and Per Module PFH Estimates - $T_1 = 2$ years

Catalog Number:	Description:	(MTBF) ⁽¹⁾	λ ⁽³⁾	Estimated PFH 1oo2
1794-IB10XOB6XT	10 Input/6 Output Combo Module	22,202,487	4.50E-08	3.19E-10
1794-OW8XT	8 Relay Output Module	18,518,519	5.40E-08	3.83E-10
1794-IE4XOE2XT	4 Input/2 Output Analog Combo Module	11,800,802	8.47E-08	6.05E-10
1794-IE8XT	8 Input analog Module	14,041,000	7.12E-08	5.07E-10
1794-OE4XT	4 Output Analog Module	11,381,744	8.79E-08	6.28E-10
1794-IF2XOF2IXT	2 Input/2 Output Isolated Analog Combo Module	6,317,918	1.58E-07	1.15E-09
1794-IF4IXT	4 Isolated Input Analog Module	7,297,140	1.37E-07	9.91E-10
1794-IF4ICFXT	4 Isolated Input Analog Module	7,297,140	1.37E-07	9.91E-10
1794-OF4IXT	4 Isolated Output Analog Module	5,493,902	1.82E-07	1.33E-09
1794-IJ2XT	2 Ch. Frequency Counter Module	11,714,128	8.54E-08	6.10E-10
1794-IRT8XT	8 TC/RTD Input Analog Module	8,204,792	1.22E-07	8.79E-10

⁽¹⁾ MTBF measured in hours.

⁽²⁾ Calculated using field-based values for components

⁽³⁾ λ = Failure Rate = 1 / MTBF

Table A.6 MTBF Field Data and Per Module PFH Estimates - $T_1 = 5$ years

Catalog Number:	Description:	(MTBF) ⁽¹⁾	λ ⁽³⁾	Estimated PFH 1oo2
1794-ACN15	ControlNet Single Media Adapter	8,223,684	1.22E-07	9.14E-10
1794-ACNR15	ControlNet Redundant Media Adapter	8,223,684	1.22E-07	9.14E-10
1794-AENT	10/100Mb Ethernet Communication Adapter	691,134	1.45E-06	1.91E-08
1794-AENTR	10/100Mb Ethernet Redundant Communication Adapter	1,268,070	7.89E-07	8.17E-09
1794-IB10XOB6	10 Input/6 Output Module	4,943,442	2.02E-07	1.59E-09
1794-IB16	16 Sink Input Module	4,105,090	2.44E-07	1.96E-09
1794-IE8	Analog Input Module	37,952,679	2.63E-08	1.87E-10
1794-IF2XOF2I	Isolated Analog Input/Output Module	25,296,960	3.95E-08	2.83E-10
1794-IF4I	Isolated Analog Input Module	11,746,343	8.51E-08	6.27E-10
1794-IJ2	Frequency Counter Module	2,418,321	4.14E-07	3.62E-09
1794-IP4	Pulse Counter Module	2,375,360	4.21E-07	3.70E-09
1794-IR8	RTD Input Module	6,191,655	1.62E-07	1.24E-09
1794-IRT8	TC/RTD/mV Input Module	1,182,438	8.46E-07	8.97E-09
1794-IT8	Thermocouple Input Module	1,564,324	6.39E-07	6.22E-09
1794-OB16	16 Source Output Module	1,883,594	5.31E-07	4.92E-09

Table A.6 MTBF Field Data and Per Module PFH Estimates - $T_1 = 5$ years

Catalog Number:	Description:	(MTBF) ⁽¹⁾	λ ⁽³⁾	Estimated PFH 1oo2
1794-OB16P	Protected Output Module	2,135,280	4.68E-07	4.21E-09
1794-OB8EP	Protected Output Module	2,389,669 ⁽²⁾	4.18E-07	3.68E-09
1794-OE4	Analog Output Module	23,807,086	4.20E-08	3.02E-10
1794-OF4I	Isolated Analog Output Module	7,191,128	1.39E-07	3.76E-10
1794-OW8	Relay Output Module	14,766,876	6.77E-08	4.94E-10
1794-TB3	Terminal Base Units	21,128,346 ⁽²⁾	4.73E-08	3.41E-10
1794-TB3G	Generic Terminal Base Units	27,320,800	3.66E-08	2.62E-10
1794-TB3GS	Generic Terminal Base Units	46,425,600	2.15E-08	1.53E-10
1794-TB3S	Terminal Base Unit	71,433,747 ⁽²⁾	1.40E-08	9.88E-11
1794-TB3T	Temperature Terminal Base Units	73,096,226 ⁽²⁾	1.37E-08	9.66E-11
1794-TB3TS	Temperature Terminal Base Units	75,763,399 ⁽²⁾	1.32E-08	9.31E-11
1794-TBN	Terminal Base Units	75,716,615	1.32E-08	9.32E-11
1794-TBNF	Fused Terminal Base Units	4,812,320 ⁽²⁾	2.08E-07	1.64E-09
1794-ACNR15XT	ControlNet Redundant Media Adapter	8,223,684	1.22E-07	9.14E-10
1794-AENTRXT	10/100Mb Ethernet Redundant Communication Adapter	1,268,070	7.89E-07	8.17E-09
1794-OB8EPXT	8 Protected Output Module	14,771,049	6.77E-08	4.93E-10
1794-IB16XT	16 Sink Input Module	35,587,189	2.81E-08	2.00E-10
1794-OB16PXT	16 Protected Output Module	26,709,401	3.74E-08	2.68E-10
1794-IB10XOB6XT	10 Input/6 Output Combo Module	22,202,487	4.50E-08	3.24E-10
1794-OW8XT	8 Relay Output Module	18,518,519	5.40E-08	3.90E-10
1794-IE4XOE2XT	4 Input/2 Output Analog Combo Module	11,800,802	8.47E-08	6.24E-10
1794-IE8XT	8 Input analog Module	14,041,000	7.12E-08	5.20E-10
1794-OE4XT	4 Output Analog Module	11,381,744	8.79E-08	6.48E-10
1794-IF2XOF2IXT	2 Input/2 Output Isolated Analog Combo Module	6,317,918	1.58E-07	1.21E-09
1794-IF4IXT	4 Isolated Input Analog Module	7,297,140	1.37E-07	1.04E-09
1794-IF4ICFXT	4 Isolated Input Analog Module	7,297,140	1.37E-07	1.04E-09
1794-OF4IXT	4 Isolated Output Analog Module	5,493,902	1.82E-07	1.42E-09
1794-IJ2XT	2 Ch. Frequency Counter Module	11,714,128	8.54E-08	6.29E-10
1794-IRT8XT	8 TC/RTD Input Analog Module	8,204,792	1.22E-07	9.16E-10

⁽¹⁾ MTBF measured in hours.

⁽²⁾ Calculated using field-based values for components

⁽³⁾ $\lambda = \text{Failure Rate} = 1 / \text{MTBF}$

Notes:

A

- Analog input modules** 3-7–3-8
- Analog output modules** 3-13–3-15
- Application program**
 - Technical SIL2 requirements 5-1

C

- Calibration** 3-7, 3-13
- Communication**
 - ControlNet 2-1
- Communications modules** 2-1
 - ControlNet module 2-1
 - Documentation 2-3
- Control and information protocol**
 - Definition Preface-1
- ControlNet module** 2-1

D

- Diagnostic coverage**
 - Definition Preface-1
- Documentation**
 - Communications modules 2-3

E

- European norm.**
 - Definition Preface-1

F

- Fault reporting**
 - Analog input modules 3-7
 - Analog output modules 3-14
 - Digital input modules 3-3
 - Digital output modules 3-4, 3-5

G

- Get system value (GSV)**
 - Definition Preface-1

I

- I/O modules** 3-1–3-19
 - Analog input modules 3-7–3-8
 - Analog output modules 3-13–3-15
 - Calibration 3-7, 3-13
 - Digital input modules 3-2–3-4
 - Digital output modules 3-6
 - Fault reporting 3-3, 3-4, 3-5, 3-7, 3-14
 - Proof tests 3-2, 3-4, 3-7, 3-13

- Wiring analog input modules 3-9–3-15
- Wiring analog output modules 3-16–3-17
- Wiring digital input modules 3-3
- Wiring digital output modules 3-5, 3-6

M

- Mean time between failures (MTBF)**
 - Definition Preface-2
- Mean time to restoration**
 - Definition Preface-2

P

- Probability of failure on demand (PFD)**
 - 1-8–1-11
 - Calculations for each catalog number 1-8
 - Definition Preface-2
- Probability of failure per hour (PFH)** 1-8–1-11
 - Calculations for each catalog number 1-10
 - Definition Preface-2
- Proof tests** 1-3, 3-2, 3-4, 3-7, 3-13

R

- RSLogix 5000** Preface-2
 - General requirements 4-1

S

- SIL compliance**
 - Distribution and weight 1-13
- SIL loop example** 1-2
- SIL2 requirements**
 - For the application program 5-1
- SIL2-certified components**
 - Complete list of ControlLogix catalog numbers 1-5
- Software**
 - General requirements 4-1
 - RSLogix 5000 Preface-2
- Spurious failure estimates** A-1

T

- Terminology**
 - Used throughout manual Preface-1

W

Wiring I/O modules

Analog input modules 3-9–3-15
Analog output modules 3-16–3-17

Digital input modules 3-3
Digital output modules 3-5, 3-6

Rockwell Automation Support

Rockwell Automation provides technical information on the Web to assist you in using its products.

At <http://www.rockwellautomation.com/support/>, you can find technical manuals, a knowledge base of FAQs, technical and application notes, sample code and links to software service packs, and a MySupport feature that you can customize to make the best use of these tools.

For an additional level of technical phone support for installation, configuration, and troubleshooting, we offer TechConnect support programs. For more information, contact your local distributor or Rockwell Automation representative, or visit <http://www.rockwellautomation.com/support/>.

Installation Assistance

If you experience a problem within the first 24 hours of installation, review the information that is contained in this manual. You can contact Customer Support for initial help in getting your product up and running.

United States or Canada	1.440.646.3434
Outside United States or Canada	Use the Worldwide Locator at http://www.rockwellautomation.com/support/americas/phone_en.html , or contact your local Rockwell Automation representative.

New Product Satisfaction Return

Rockwell Automation tests all of its products to ensure that they are fully operational when shipped from the manufacturing facility. However, if your product is not functioning and needs to be returned, follow these procedures.

United States	Contact your distributor. You must provide a Customer Support case number (call the phone number above to obtain one) to your distributor to complete the return process.
Outside United States	Please contact your local Rockwell Automation representative for the return procedure.

Documentation Feedback

Your comments will help us serve your documentation needs better. If you have any suggestions on how to improve this document, complete this form, publication [RA-DU002](#), available at <http://www.rockwellautomation.com/literature/>.

Rockwell Otomasyon Ticaret A.Ş., Kar Plaza İş Merkezi E Blok Kat:6 34752 İçerenköy, İstanbul, Tel: +90 (216) 5698400

www.rockwellautomation.com

Power, Control and Information Solutions Headquarters

Americas: Rockwell Automation, 1201 South Second Street, Milwaukee, WI 53204-2496 USA, Tel: (1) 414.382.2000, Fax: (1) 414.382.4444

Europe/Middle East/Africa: Rockwell Automation NV, Pegasus Park, De Kleetlaan 12a, 1831 Diegem, Belgium, Tel: (32) 2 663 0600, Fax: (32) 2 663 0640

Asia Pacific: Rockwell Automation, Level 14, Core F, Cyberport 3, 100 Cyberport Road, Hong Kong, Tel: (852) 2887 4788, Fax: (852) 2508 1846

Publication 1794-RM001G-EN-P - December 2011

Supersedes Publication 1794-RM001F-EN-P - September 2011

Copyright © 2011 Rockwell Automation, Inc. All rights reserved. Printed in the U.S.A.